

## PA690 Rugged Mobile Computer

- PA690 -

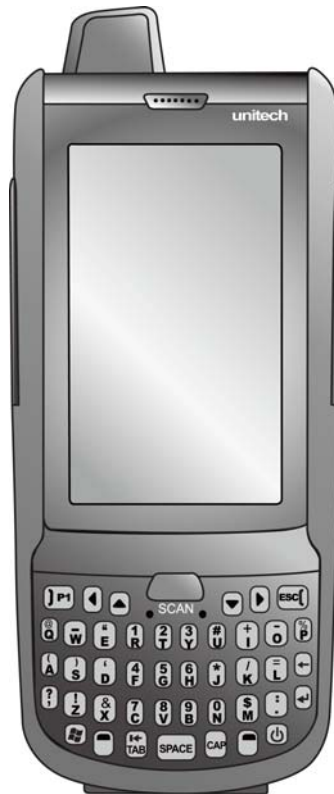





## Quick Reference Guide

---

400853G Version 1.0

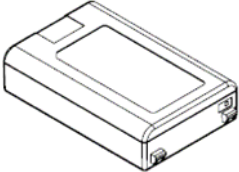
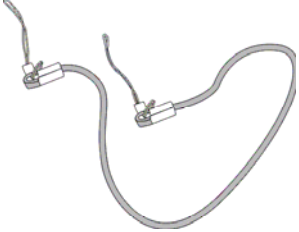

## PA690 Product Introduction & Accessory Kit

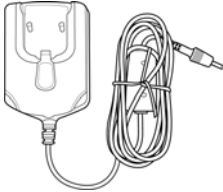
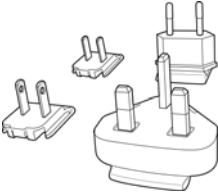
		
<p>PA690 Terminal</p>	<p>Manual CD</p>	
		
<p>Stylus</p>	<p>Battery</p>	
		
<p>Elastic Stylus String</p>	<p>Hand Strap</p>	
		
<p>Power Adaptor</p>	<p>Plugs</p>	

## PA690 Front and Right View

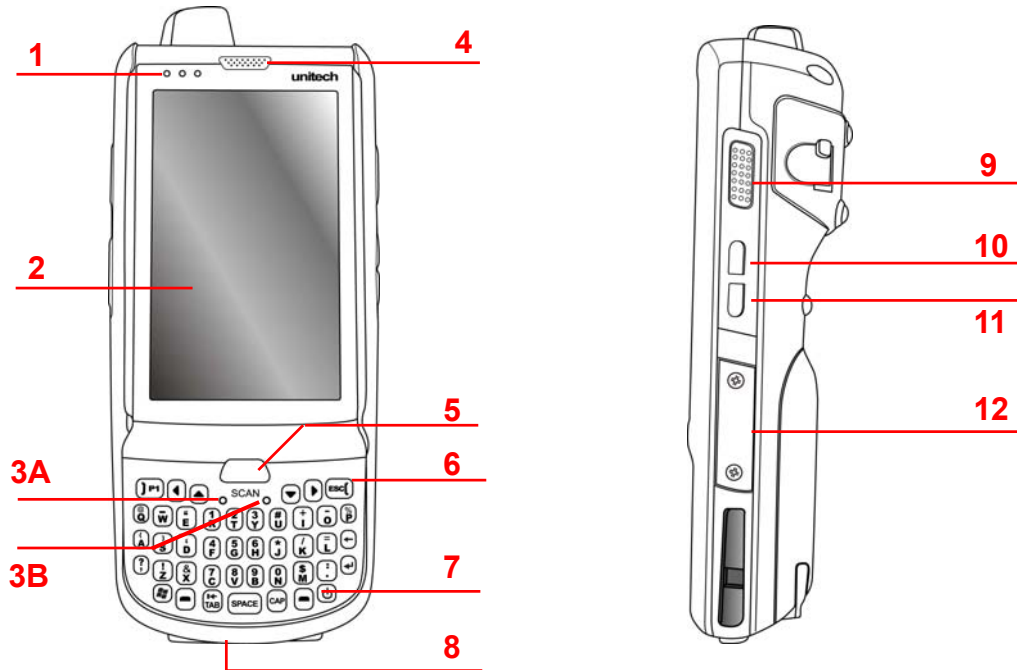

- |                    |                            |
|--------------------|----------------------------|
| 1 LED indicators   | 7 Power button             |
| 2 LCD touch screen | 8 Universal connector      |
| 3A Microphone      | 9 Scanner trigger button   |
| 3B Reset button    | 10 Mute / vibration button |
| 4 Receiver         | 11 Camera button           |
| 5 Scan button      | 12 Memory card slot        |
| 6 Keypad           |                            |

## Turning ON the PA690 for the First Time

After you have initially charged your device for about 16 hours, the device is ready to be used. You can now start up your device. You can then calibrate the display, learn some basic stylus usage, and set up the system time zone, date and time.

Power-On Button 

Turn ON your device by pressing the power button on the front panel.

## PA690 Rear and Left View

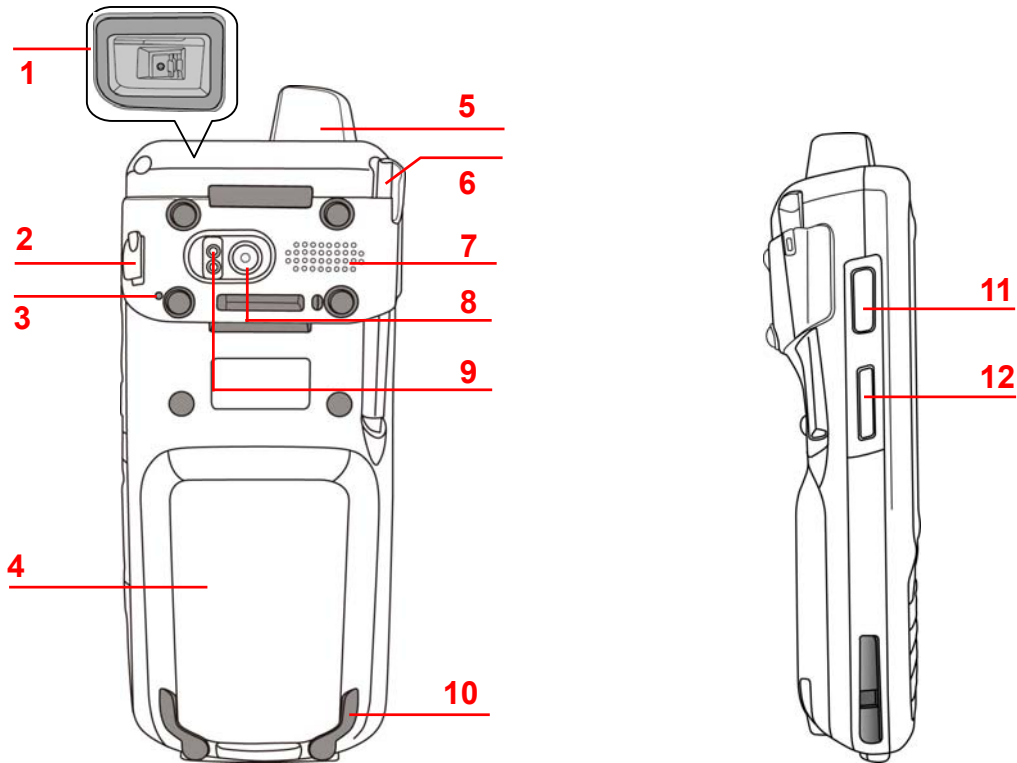

- |                          |                            |
|--------------------------|----------------------------|
| 1 Barcode scanner window | 7 Speaker                  |
| 2 Headphone jack         | 8 5M/AF camera             |
| 3 Microphone             | 9 LED flash light          |
| 4 Battery compartment    | 10 Battery compartment tab |
| 5 Antenna                | 11 Scanner trigger button  |
| 6 Stylus                 | 12 Volume up/down          |

## Installing the Battery

1. Open the battery compartment cover by sliding the tabs on both sides in the direction of the arrows shown and lift the cover up.
2. Push up the backup battery switch to the "ON" position by using a stylus to turn on the backup battery.
3. Slide and position the battery pack, making sure the battery contacts are aligned with the contacts in the compartment.
4. Use your thumb to snap the battery down for it to be in place.
5. Replace the battery compartment cover by pushing down on the tabs and sliding them back into place as shown.

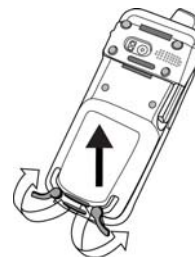
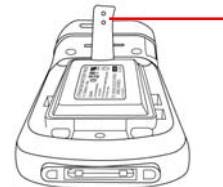
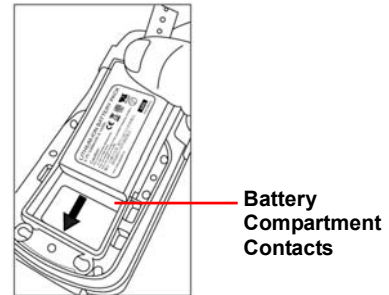
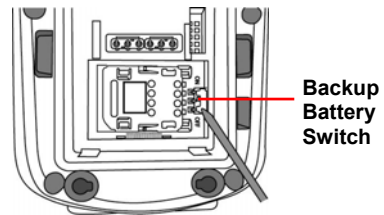
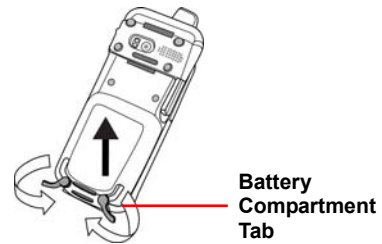

**NOTE:** Make sure the battery compartment cover is securely closed, or you may be unable to turn ON the terminal.

## Charging the Battery

**CAUTION:** Turn ON the backup battery switch before charging the battery.

Data you entered may not be properly stored until the built-in backup battery has been adequately charged.

1. Press and hold the release button on both sides of the USB charging cable and connect it to the PA690 (1).
2. Plug the AC adapter cable into the power jack of the USB charging cable (2).
3. Plug the AC adapter cord into an electrical outlet (3).

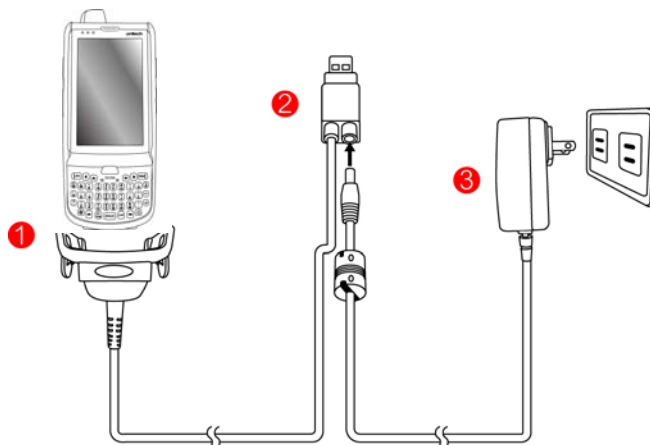

## Using the MicroSD memory card

1. Remove the two screws on the MicroSD slot shield and remove the shield.
2. Insert the MicroSD card with the notched corner as shown.
3. Push the card into the slot until you feel the MicroSD card click into place.
4. Screw the MicroSD compartment cover back into place.

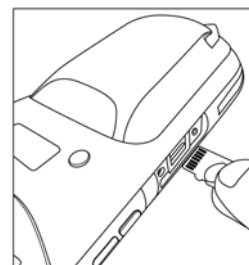
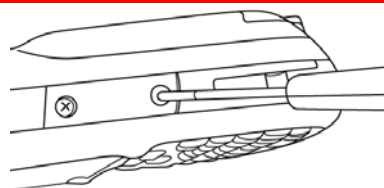

## Using the SIM card

The PA690 has a slot for a GPRS SIM card inside the battery compartment.

**CAUTION:** Before installing the SIM card, please backup your data to prevent data loss because of a low backup battery.

1. Remove the battery compartment cover and the main battery.
2. Slide the cover of the SIM card slot to the right to release the latch.

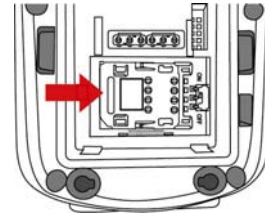

3. Pull open the cover with thumb.

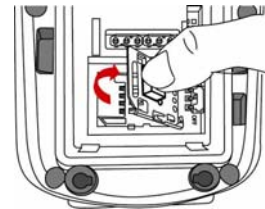

4. Insert the SIM card into the cover with the notched corner up, the contact side of the SIM card facing down.

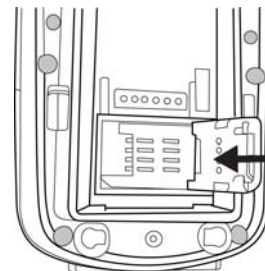

5. Close the cover over the slot, and then slide the cover to the left to lock the SIM card.

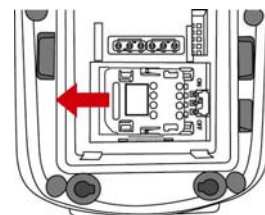

6. Put the battery back into the battery compartment and replace the battery compartment cover.

## Keypads and Function Buttons

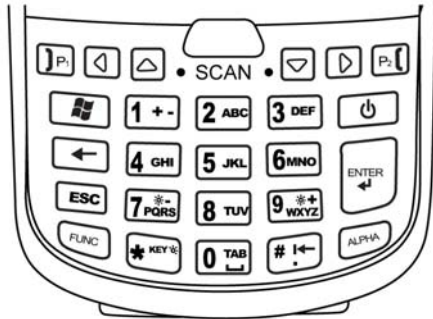

Numeric Keypad



























Qwerty Keypad

Key	Description	Key	Description
	Power key		Escape key
	Enter key		Backspace key
	Tab key		Function key
	Alpha key, toggle between numeric and alphabetic entry modes		Windows key
	Alphanumeric keys		Hang-off key
	Answer key		Left cursor key
	Right cursor key		Up cursor key
	Down cursor key		



























When the PA690 turns on, the numeric mode is on by default. When you toggle to alpha mode, the CAPS mode is off by default. Use the Alpha key to toggle to CAPS.

## Using Function keys











### For Qwerty Keypad

Key	Description	Key	Description
 + 	Keypad backlight toggling	 + 	Screen backlight toggling
 + 	Decrease screen backlight brightness	 + 	Increase screen backlight brightness
 + 	Softkey 2	 + 	Softkey 1
 + 	END TALK	 + 	TALK
 + 	Scanner setting	 + 	Task manager execution
 + 	Device information	 + 	Power management





### For Numeric Keypad

Key	Description	Key	Description
 + 	Calibration	 + 	Screen backlight toggling
 + 	Keypad backlight toggling	 + 	Power management
 + 	Device information	 + 	Softkey 1
 + 	Softkey 2	 + 	Decrease screen backlight brightness
 + 	Increase screen backlight brightness	 + 	TALK
 + 	END TALK	 + 	Task manager execution
 + 	Scanner setting		

## Using Alpha keys

Key	Alpha Off	Alpha On	
		CAPS Off	CAPS On
	0	Space, @, \$, ", 0	Space, @, \$, ", 0
	1	+, -, \, %, 1	+, -, \, %, 1
	2	a, b, c, 2	A, B, C, 2
	3	d, e, f, 3	D, E, F, 3
	4	g, h, i, 4	G, H, I, 4
	5	j, k, l, 5	J, K, L, 5
	6	m, n, o, 6	M, N, O, 6
	7	p, q, r, 7	P, Q, R, 7
	8	t, u, v, 8	T, U, V, 8
	9	w, x, y, z, 9	W, X, Y, Z, 9
	#	, ; ! . /	, ; ! . /

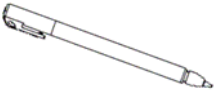
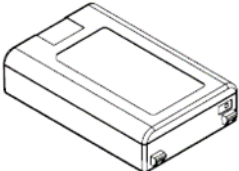
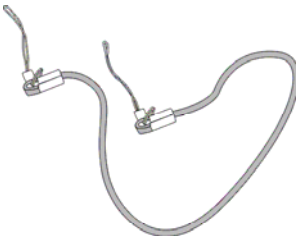
## PA690 Produkteinführung & Zubehör-Set

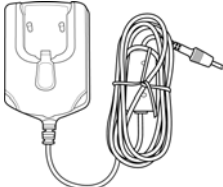
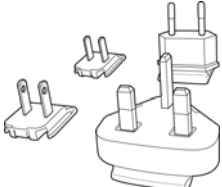
		
<p>PA690 Gerät</p>		<p>Anleitungs-CD</p>
		
<p>Stylus</p>	<p>Akku</p>	
		
<p>Flexibles Stylus-Band</p>		<p>Handschlaufe</p>
		
<p>Netzteil</p>	<p>Stecker</p>	

## PA690 Vordere und rechte Ansicht

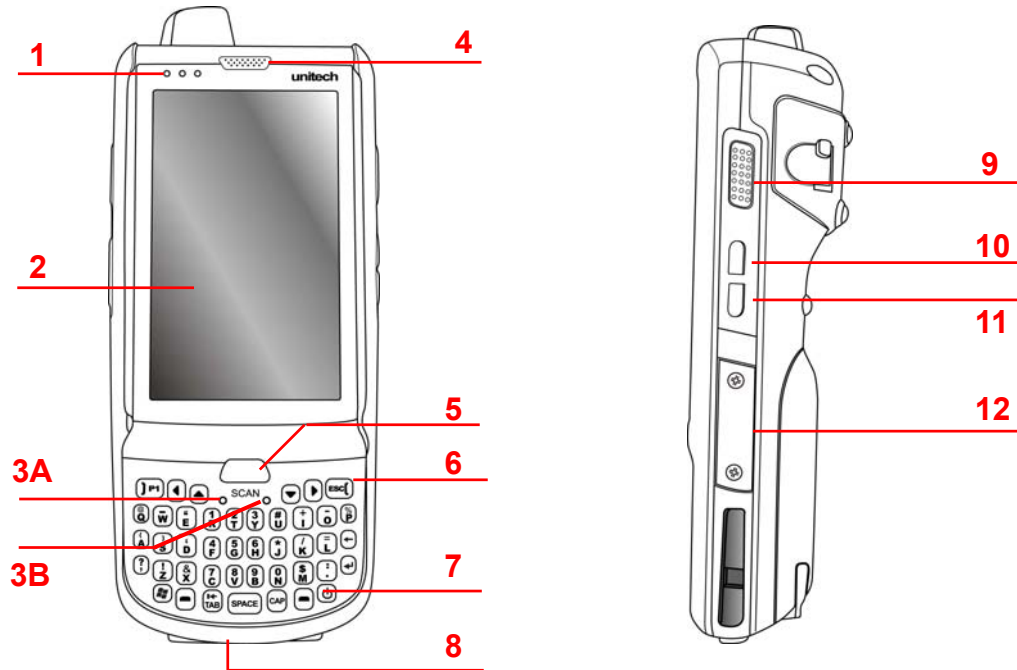

- |                   |                             |
|-------------------|-----------------------------|
| 1 LED-Anzeigen    | 7 Einschalttaste            |
| 2 LCD Touchscreen | 8 Universalanschluss        |
| 3A Mikrophon      | 9 Scanner Auslösetaste      |
| 3B Rücksteltaste  | 10 Mute / Vibration-Taste   |
| 4 Empfänger       | 11 Kamera-Taste             |
| 5 Scan-Taste      | 12 Speicherkartensteckplatz |
| 6 Tastenfeld      |                             |

## PA690 erstmalig einschalten

Nachdem Sie das Gerät für etwa 16 Stunden geladen haben, kann es benutzt werden. Sie können das Gerät nun starten und den Bildschirm kalibrieren, die grundlegende Benutzung des Stylus lernen, sowie die Zeitzone, Datum und Uhrzeit des Systems einstellen.

Einschalttaste 

Schalten Sie Ihr Gerät durch Drücken der Einschalttaste an der Vorderseite ein.

## PA690 Hintere und linke Ansicht

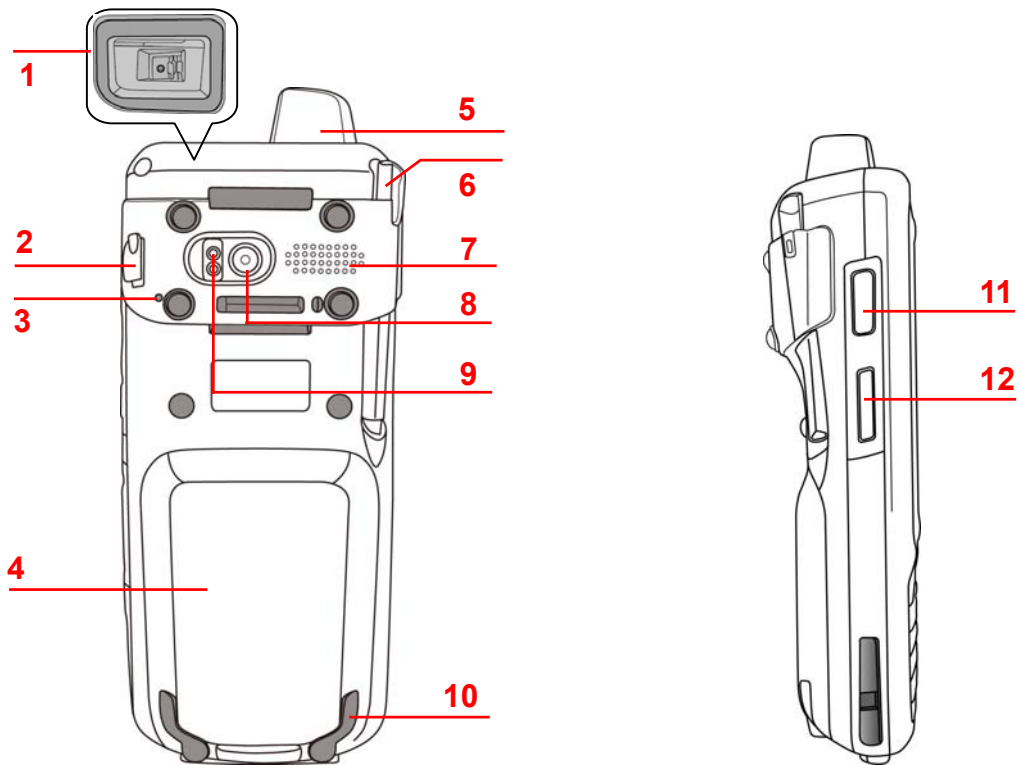

1 Barcodescanner Fenster

2 Kopfhörerbuchse

3 Mikrofon

4 Batteriefach

5 Antenne

6 Stylus

7 Lautsprecher

8 5M/AF-Kamera

9 LED Blitzlicht

10 Batteriefachverriegelung

11 Scanner Auslösetaste

12 Lautstärketaste oben/unten

## Einsetzen der Batterie

1. Öffnen Sie die Abdeckung des Batteriefachs, indem Sie die Verriegelungen an beiden Seiten in die Richtungen der Pfeile schieben und dann die Abdeckung abnehmen.
2. Drücken Sie den Schalter der Backup-Batterie in die Position "EIN", indem Sie einen Stylus verwenden, um die Backup-Batterie einzuschalten.
3. Schieben und legen Sie die Batterie ein und stellen Sie sicher, dass die Kontakte der Batterie mit den Kontakten im Fach verbunden sind.
4. Ziehen Sie an der Plastiklasche, bis die Batterie eingelegt ist.
5. Bringen Sie die Abdeckung des Batteriefachs wieder an. Drücken Sie die Verriegelungen nach unten und schieben Sie sie wie abgebildet wieder zurück in ihre Positionen.

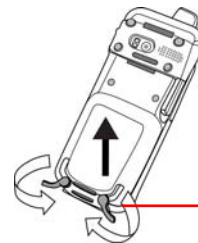

Batteriefachverriegelung

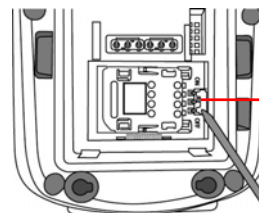

Backupbatterieschalter

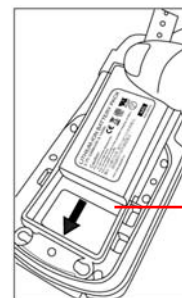

Batteriefachkontakte



Plastiklasche

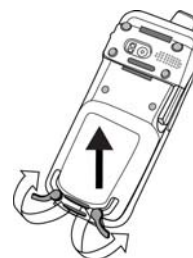

**HINWEIS:** Stellen Sie sicher, dass die Abdeckung des Batteriefachs fest verschlossen ist. Anderenfalls lässt sich das Gerät vielleicht nicht EIN schalten.

## Aufladen der Batterie

**ACHTUNG:** Schalten Sie vor dem Aufladen der Batterie die Backupbatterie ein. Daten, die Sie eingegeben haben, werden nicht sicher gespeichert, wenn die integrierte Backupbatterie nicht ausreichend aufgeladen wurde.

1. Drücken und halten Sie die Freigabetasten an beiden Seiten des USB Ladekabels gedrückt und verbinden Sie es mit dem PA690 (1).
2. Stecken Sie das AC Adapterkabel in den Stromanschluss des USB Ladekabels (2).
3. Verbinden Sie das AC Adapterkabel mit einer Steckdose (3).

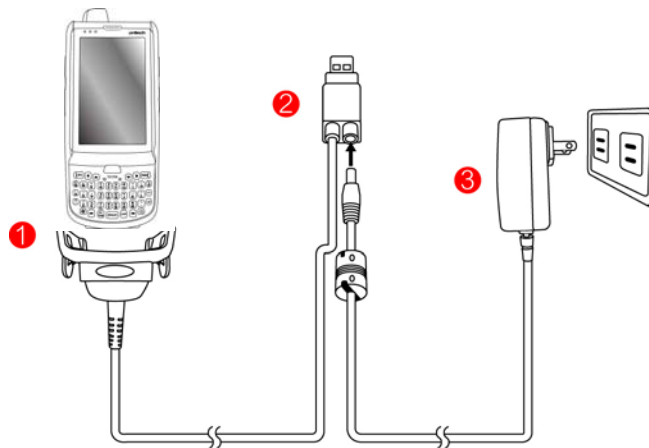

## Benutzung der MicroSD Speicherkarte

1. Entfernen Sie die beiden Schrauben an der Abdeckung des MicroSD-Speicherkartenplatzes und entfernen Sie die Abdeckung.
2. Legen Sie die MicroSD-Karte mit der geriffelten Ecke wie abgebildet ein.

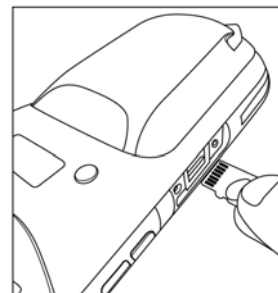
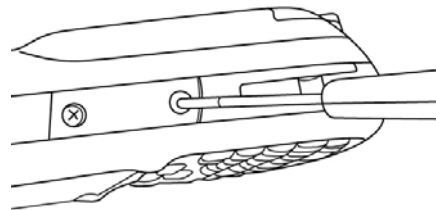

## Benutzung der SIM-Karte

Der PA690 besitzt einen Steckplatz für GPRS SIM-Karten innerhalb des Batteriefachs.

**ACHTUNG:** Sichern Sie bitte Ihre Daten vor dem Einlegen der SIM-Karte, um Datenverluste wegen einer schwachen Backupbatterie zu vermeiden.

1. Entfernen Sie das Batteriefach und die Hauptbatterie.
2. Schieben Sie die Abdeckung des SIM-Karten Steckplatzes nach rechts, um die Verriegelung freizugeben.

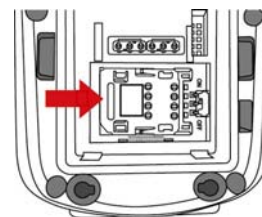

3. Ziehen Sie die Abdeckung mit dem Daumen ab.

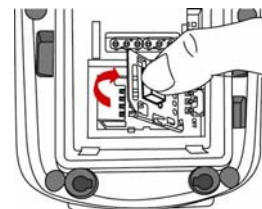

4. Legen Sie die SIM-Karte mit der geriffelten Ecke nach oben und der Kontaktseite der SIM-Karte nach unten zeigend wie abgebildet ein.

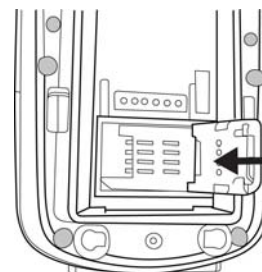

5. Drücken Sie die Abdeckung auf den Steckplatz und schieben Sie sie dann nach links, um die SIM-Karte zu sichern.

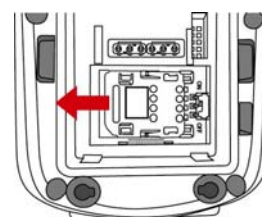

6. Legen Sie die Batterie zurück in das Batteriefach und bringen Sie das Batteriefach wieder an.

## Tastentfeld und Funktionstasten

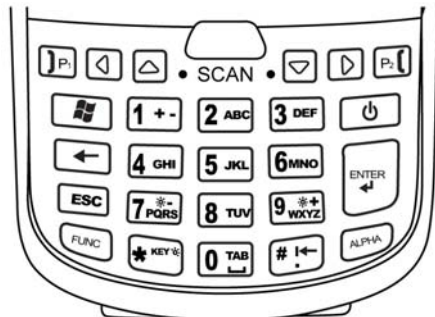

Numerische Tastatur



Qwerty Tastatur

Taste	Beschreibung	Taste	Beschreibung
	Einschalttaste		Escape-Taste
	Eingabetaste		Löschtaste
	Tab-Taste		Funktionstaste
	Alphataste, zwischen numerischem und alphabetischem Eingabemodus wechseln		Windows-Taste
	Alphanumerische Tasten		Auflegen-Taste
	Antworttaste		Linke Cursor-Taste
	Rechte Cursor-Taste		Nach Oben Cursor-Taste
	Nach Unten Cursor-Taste		



















Nach dem Start von PA690 ist standardmäßig der Numerische Modus eingeschaltet. Wenn Sie in den Alphamodus wechseln, ist der CAPS Modus ausgeschaltet. Benutzen Sie bitte die Alphataste, um zu CAPS zu wechseln.

## Verwendung der Funktionstasten

### Für Qwerty Tastatur

Taste	Beschreibung	Taste	Beschreibung
 + 	Tastenfeld Hintergrundbeleuchtung	 + 	Bildschirm Hintergrundbeleuchtung
 + 	Helligkeit der Bildschirm Hintergrundbeleuchtung verringern	 + 	Helligkeit der Bildschirm Hintergrundbeleuchtung erhöhen
 + 	Softwaretaste 2	 + 	Softwaretaste 1
 + 	SPRECHEN BEENDEN	 + 	SPRECHEN
 + 	Scanner-Einstellung	 + 	Task Manager ausführen
 + 	Geräteinformationen	 + 	Energieverwaltung

### Für numerische Tastatur

Taste	Beschreibung	Taste	Beschreibung
 + 	Kalibrierung	 + 	Bildschirm Hintergrundbeleuchtung
 + 	Tastenfeld Hintergrundbeleu- chtung	 + 	Energieverwaltung
 + 	Geräteinformationen	 + 	Softwaretaste 1
 + 	Softwaretaste 2	 + 	Helligkeit der Bildschirm Hintergrundbeleu- chtung verringern
 + 	Helligkeit der Bildschirm Hintergrundbeleu- chtung erhöhen	 + 	SPRECHEN
 + 	SPRECHEN BEENDEN	 + 	Task Manager ausführen
 + 	Scanner-Einstellung		











Copyright 2011 Unitech Electronics Co., Ltd. Alle Rechte vorbehalten.  
Unitech ist eine eingetragenes Markenzeichen von Unitech Electronics Co., Ltd.

Unitech electronics co., ltd.



5F., No.135, Ln. 235, Baoqiao Rd., Xindian Dist., New Taipei City 231, Taiwan (R.O.C.)

• Tel: + 886 2 89121122 • Fax: +886 2 89121810 • website: www.ute.com

## Verwendung der Alphatasten

Taste	Alpha Aus	Alpha Ein	
		CAPS Aus	CAPS Ein
	0	Leerzeichen, @, \$, ", 0	Leerzeichen, @, \$, ", 0
	1	+, -, \, %, 1	+, -, \, %, 1
	2	a, b, c, 2	A, B, C, 2
	3	d, e, f, 3	D, E, F, 3
	4	g, h, i, 4	G, H, I, 4
	5	j, k, l, 5	J, K, L, 5
	6	m, n, o, 6	M, N, O, 6
	7	p, q, r, 7	P, Q, R, 7
	8	t, u, v, 8	T, U, V, 8
	9	w, x, y, z, 9	W, X, Y, Z, 9
	#	, ; ! . /	, ; ! . /

## Presentación del producto y Kit de accesorios del PA690

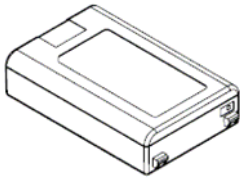
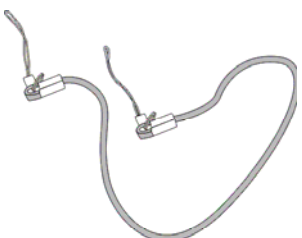
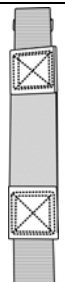
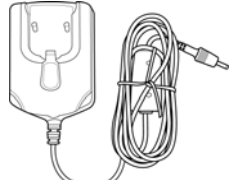
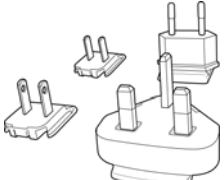
		
Terminal PA690		CD con manual
		
Lápiz puntero	Batería	
		
Cinta elástica del puntero		Cinta para la mano
		
Adaptador de la fuente de alimentación	Conexiones	

## Vista Lateral Derecha y Frontal del PA690

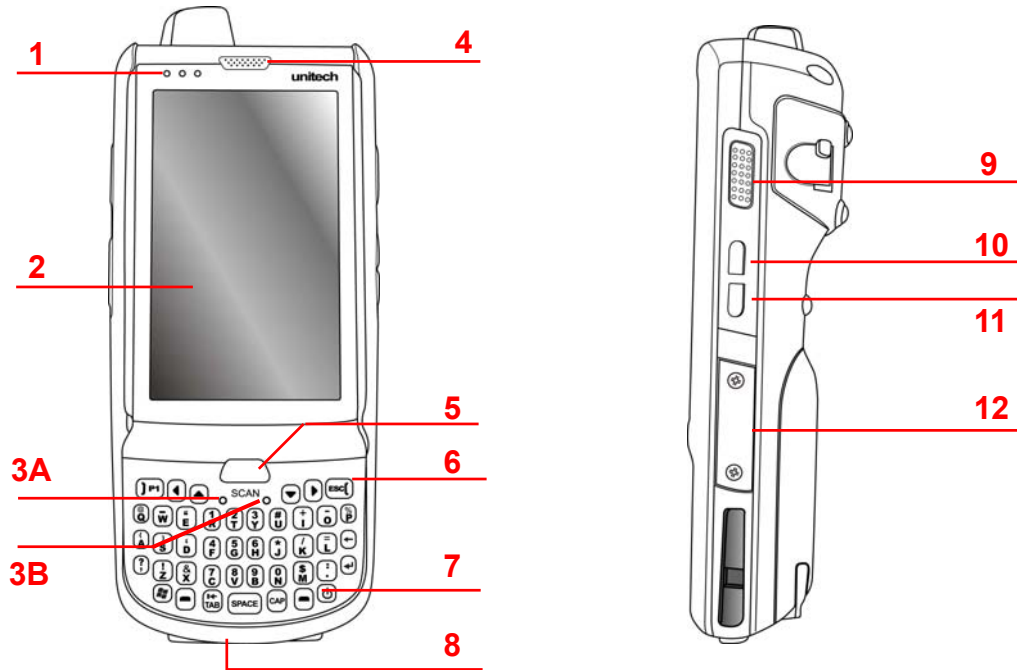

- |    |                     |    |                                  |
|----|---------------------|----|----------------------------------|
| 1  | Indicadores LED     | 7  | Botón de Encendido               |
| 2  | Pantalla LCD Táctil | 8  | Conector universal               |
| 3A | Micrófono           | 9  | Botón del accionador del escáner |
| 3B | Botón de reinicio   | 10 | Botón de silencio / vibración    |
| 4  | Receptor            | 11 | Botón de cámara                  |
| 5  | botón de escaneo    | 12 | Ranura de tarjeta de memoria     |
| 6  | Teclado             |    |                                  |

## Encendido de la PA690 por primera vez

Después de haber iniciado la recarga de su aparato por aproximadamente 16 horas, el aparato está listo para ser usado. Ahora puedes iniciar su aparato y podrás calibrar la pantalla, aprender algunas formas de aplicaciones básicas y montarás el huso horario del sistema, la fecha y hora.

Botón de encendido 

Encienda su aparato apretando el botón de encendido en el panel frontal.

## **PA690 Vista Lateral Izqda. y posterior**

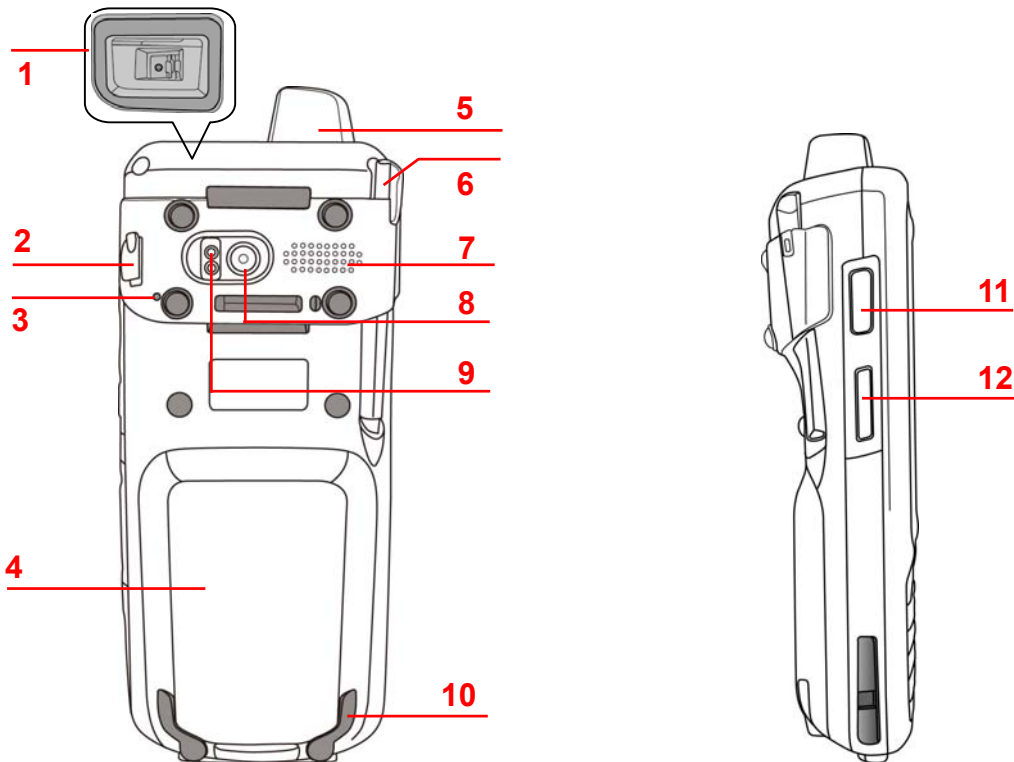

- |   |   |
|---|---|
| <b>1</b> Ventana del scanner de código de barra | <b>7</b> Altavoces                              |
| <b>2</b> Conexión de los auriculares            | <b>8</b> Cámara 5M/AF                           |
| <b>3</b> Micrófono                              | <b>9</b> Linterna de LED                        |
| <b>4</b> Compartimento de batería               | <b>10</b> Lengüeta del compartimento de batería |
| <b>5</b> Antena                                 | <b>11</b> Botón Engatillador de Scanner         |
| <b>6</b> Lápiz puntero                          | <b>12</b> Subir / Bajar Volumen                 |

## Instalando la Batería

1. Abra la tapa del compartimiento de batería corriendo las lengüetas en los costados hacia la dirección de las flechas señaladas y levante la tapa para arriba.
2. Deslice hacia arriba el interruptor de la batería de seguridad para que esté en la posición "ON" utilizando un stylus para activar la batería de seguridad.
3. Deslice y coloque la batería asegurándose de que los contactos estén alineados con los contactos del compartimento.
4. Presione las pestaña de plástico hasta que la pila se coloque en su sitio.
5. Reponga la tapa del compartimiento de batería, empuje hacia abajo las lengüetas y córralos de vuelta hacia el lugar señalado.

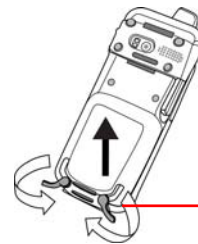

Lengüeta del compartimiento de batería

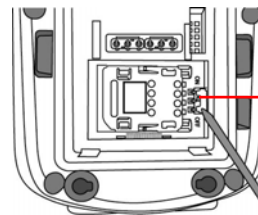

Interruptor de la batería de respaldo

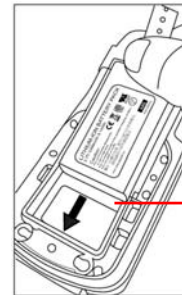

Contactos del compartimiento de la batería



Cinta plástica

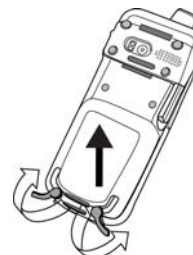

**NOTA:** Asegure que la tapa del compartimiento de batería esté firmemente cerrada, ya que de lo contrario no podrá ENCENDER la terminal.

## Recargando la Batería

**PRECAUCIÓN:** ENCIENDA el interruptor de la batería de refuerzo antes de recargar la batería. Datos introducidos pueden no estar guardados hasta que la batería de refuerzo integrada haya sido recargada adecuadamente.

1. Presione y sujete los botones de desprendimiento a los costados del cable de recarga USB y conéctelo al PA690 (1).
2. Enchufe el cable de adaptador AC dentro de la clavija del cable de recarga USB (2).
3. Enchufe el cable de adaptador AC dentro de la toma de corriente eléctrica (3).

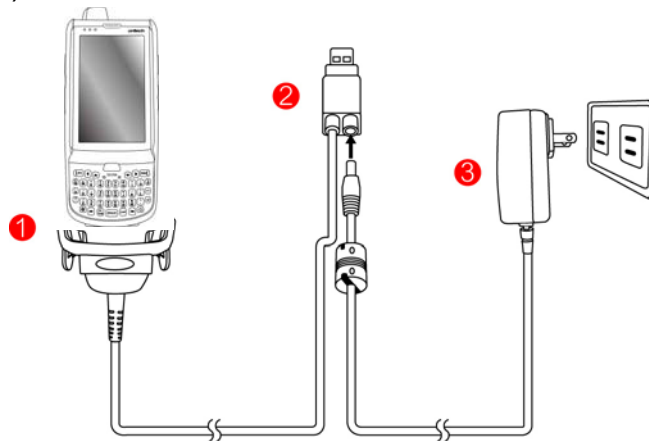

## Usando la tarjeta de memoria MicroSD

1. Extraiga los dos tornillos de la protección de la ranura MicroSD y extraiga dicha protección.

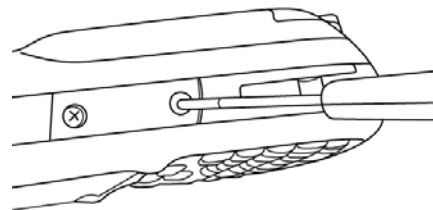

2. Inserte la tarjeta MicroSD con la esquina cortada según lo señalado.

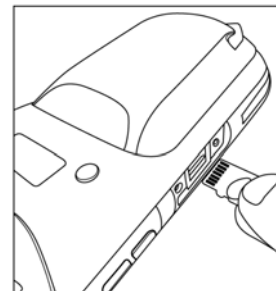

## Usando la tarjeta SIM

El PA690 tiene una ranura para la tarjeta GPRS SIM dentro del compartimiento de batería.

**PRECAUCIÓN:** Antes de instalar la tarjeta SIM, favor haga copia de sus datos para evitar pérdida de datos a causa de batería baja en la batería de respaldo.

1. Remueva la tapa del compartimiento de batería y la batería principal.
2. Deslice la tapa de la ranura de la tarjeta SIM hacia la derecha para soltar el seguro.

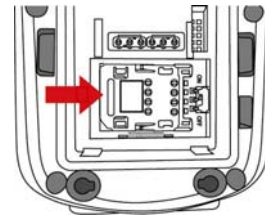

3. Empuje y abra la cubierta con los dedos pulgares.

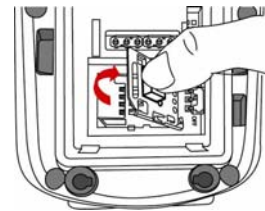

4. Inserte la tarjeta SIM dentro de la carcasa con la esquina cortada hacia arriba y el lateral de los contactos de la tarjeta SIM esté mirando hacia abajo.

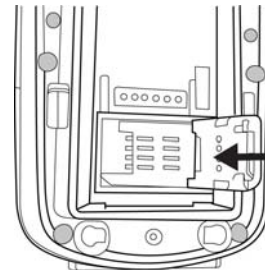

5. Presione hacia abajo la carcasa de la ranura, luego deslice la carcasa hacia la izquierda para asegurar la tarjeta SIM.

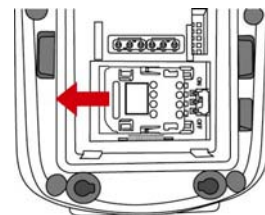

6. Ponga la batería de vuelta dentro del compartimiento de batería y reponga la tapa del compartimiento de batería.

## Teclados y Botones de Función

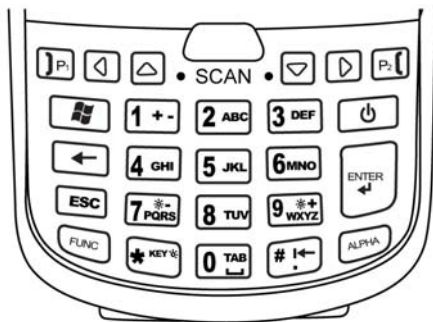

Teclado Numérico



















Teclado Qwerty

Tecla	Descripción	Tecla	Descripción
	Tecla Encendido		Tecla de Escape
	Tecla Enter		Tecla de Retroceso
	Tecla de Tabular		Tecla de función
	Tecla Alfa, permite cambiar entre modo numérico y alfabético		Tecla Windows
	Teclas alfanuméricas		Tecla de colgar
	Tecla de responder		Tecla Izquierda del cursor
	Tecla derecha del cursor		Tecla Arriba del cursor
	Tecla Abajo del cursor		



























Cuando se carga el PA690, la condición preconfigurada es de Modo Numérico on. Cuando cambia al Modo Alfabética, la condición preconfigurada es de modo CAPS off. Use la Tecla Alfa para cambiar entre CAPS on y off.

## Utilizando teclas de Función











### Para el teclado Qwerty

Tecla	Descripción	Tecla	Descripción
 + 	Iluminación intermitente del teclado	 + 	Iluminación intermitente de la pantalla
 + 	Disminuir el brillo de la iluminación posterior de la pantalla	 + 	Aumentar el brillo de la iluminación posterior de la pantalla
 + 	Tecla Multifunción 2	 + 	Tecla Multifunción 1
 + 	Finalizar Hablar	 + 	Hablar
 + 	Configuración del escáner	 + 	Ejecución del gestor de tareas
 + 	Información del dispositivo	 + 	Gestión energética





### Para el teclado numérico

Tecla	Descripción	Tecla	Descripción
 + 	Calibrado	 + 	Iluminación intermitente de la pantalla
 + 	Iluminación intermitente del teclado	 + 	Gestión energética
 + 	Información del dispositivo	 + 	Tecla Multifunción 1
 + 	Tecla Multifunción 2	 + 	Disminuir el brillo de la iluminación posterior de la pantalla
 + 	Aumentar el brillo de la iluminación posterior de la pantalla	 + 	Hablar
 + 	Finalizar Hablar	 + 	Ejecución del gestor de tareas
 + 	Configuración del escáner		

## Tecla Alfa

Tecla	Alfa Off	Alfa On	
		CAPS Off	CAPS On
	0	Space, @, \$, ", 0	Space, @, \$, ", 0
	1	+, -, \, %, 1	+, -, \, %, 1
	2	a, b, c, 2	A, B, C, 2
	3	d, e, f, 3	D, E, F, 3
	4	g, h, i, 4	G, H, I, 4
	5	j, k, l, 5	J, K, L, 5
	6	m, n, o, 6	M, N, O, 6
	7	p, q, r, 7	P, Q, R, 7
	8	t, u, v, 8	T, U, V, 8
	9	w, x, y, z, 9	W, X, Y, Z, 9
	#	, ; ! . /	, ; ! . /

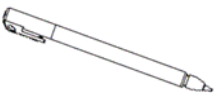
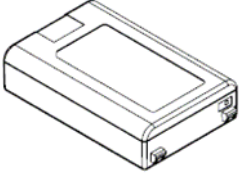
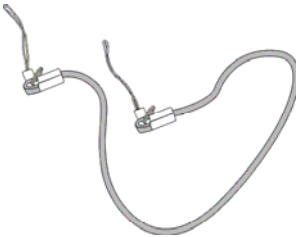
## PA690 Introduction du produit et du kit d'accessoires

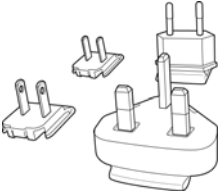
		
PA690 Terminal		Manuel sur CD-ROM
		
Stylet	Batterie	
		
Lanière élastique pour le stylet		Dragonne
		
Adaptateur secteur	Adaptateur de prise	

## PA690 Vue de face et du côté droit

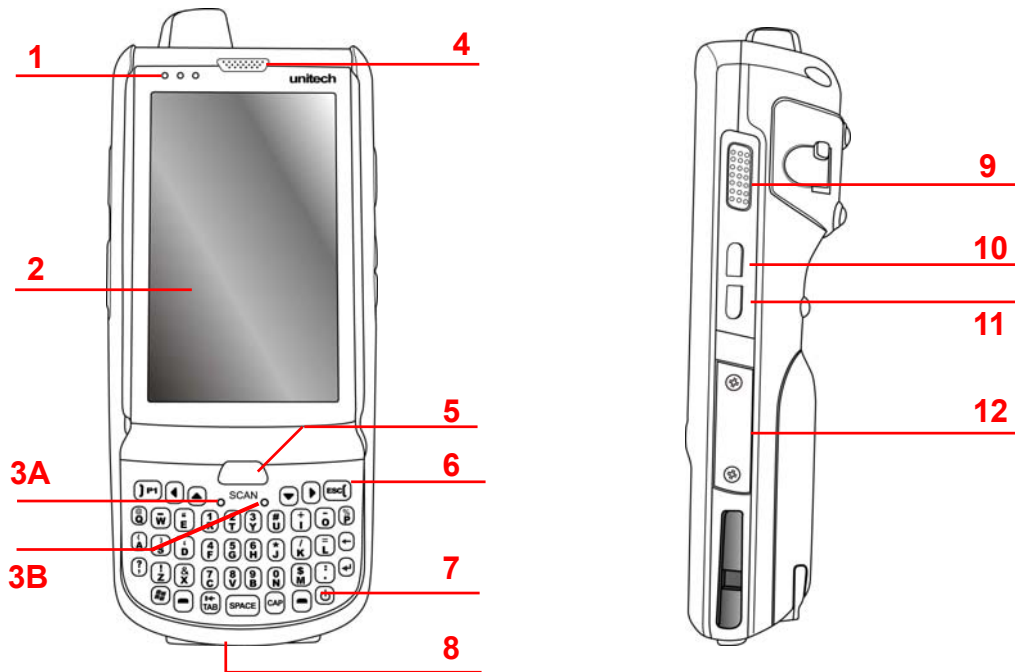

- |                               |                                     |
|-------------------------------|-------------------------------------|
| 1 Indicateurs à DEL           | 7 Touche de démarrage               |
| 2 Ecran tactile LCD           | 8 Connecteur universel              |
| 3A Microphone                 | 9 Touche pour déclencher le scanner |
| 3B Touche de réinitialisation | 10 Muet bouton / vibrations         |
| 4 Récepteur                   | 11 Bouton Appareil photo/Caméra     |
| 5 le bouton Scan              | 12 Ouverture de la carte de mémoire |
| 6 Clavier                     |                                     |

## Mettre en marche pour la première fois le PA690

Après que vous avez chargé votre appareil pour 16 heures au départ, l'appareil est mis en service. Vous pouvez démarrer votre appareil et donc vous allez calibrer l'affichage, apprendre quelques modes d'emploi basiques et régler la zone horaire, la date et l'heure du système.

Bouton de mise en marche 

Allumer votre appareil en appuyant la touche de démarrage sur le panneau avant.

## PA690 Vue de l'arrière et du côté gauche

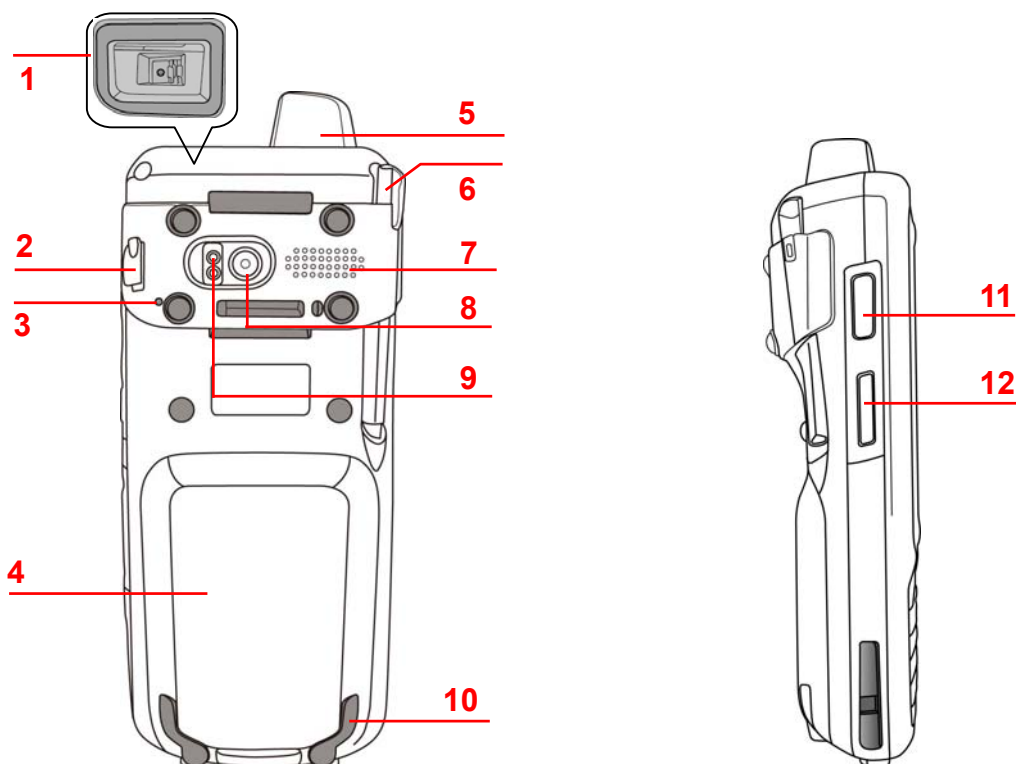

- |   |                                 |    |                                   |
|---|---------------------------------|----|-----------------------------------|
| 1 | Code à barres du scanner window | 7  | Haut-parleur                      |
| 2 | Fiche d'écouteur                | 8  | Caméra 5M/AF                      |
| 3 | Microphone                      | 9  | Eclair LED                        |
| 4 | Compartiment de pile            | 10 | Attache du capot de pile          |
| 5 | Antenne                         | 11 | Touche pour déclencher le scanner |
| 6 | Styler                          | 12 | Volume +/-                        |

## Installer la pile

1. Ouvrir le capot de pile en glissant les attaches de chaque côté dans la direction des flèche et enlever le capot.

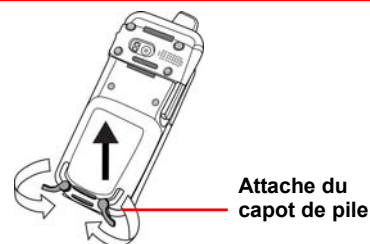

2. Pouser commutateur de batterie de secours dans la position "ON (ACTIVÉ)" en utilisant un stylet pour mettre en fonction la batterie de secours.

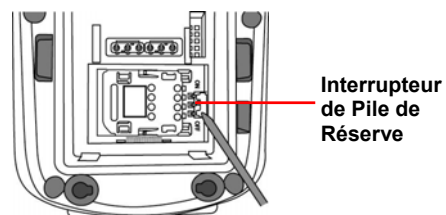

3. Placez le jeu de batterie, en veillant que les contacts de batterie sont alignés avec les contacts dans le compartiment.

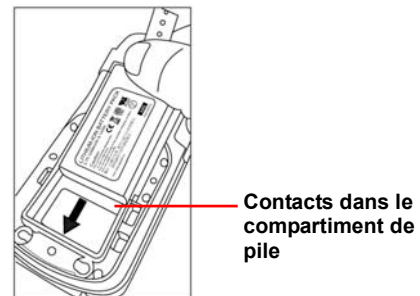

4. Tirez sur la langue en plastique jusqu'à ce que la batterie soit en place.

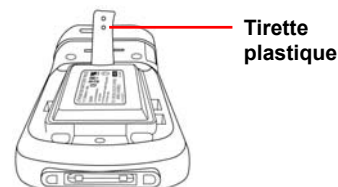

5. Installer le capot de pile, abaisser les attaches et les glisser en position comme le montre le dessin.

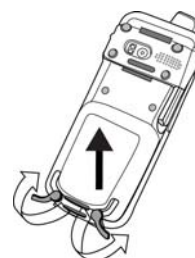

**NOTE :** Vérifier que le capot de pile est bien fermé, sinon vous seriez incapable d'allumer le terminal.

## Chargement de la pile

**PRÉCAUTION :** Activez la touche de secours de batterie avant de charger la batterie. Les données que vous avez entrées risquent de ne pas être sauvegardées correctement jusqu'au Mise en place correct de la batterie de secours incorporée.

1. Appuyer et maintenir la touche de déverrouillage sur chaque côté du fil de chargement USB et le brancher à PA690 (1).
2. Brancher le fil d'adaptateur AC au jack d'énergie du fil de chargement USB (2).
3. Brancher le cordon d'adaptateur AC à la prise de courant (3).

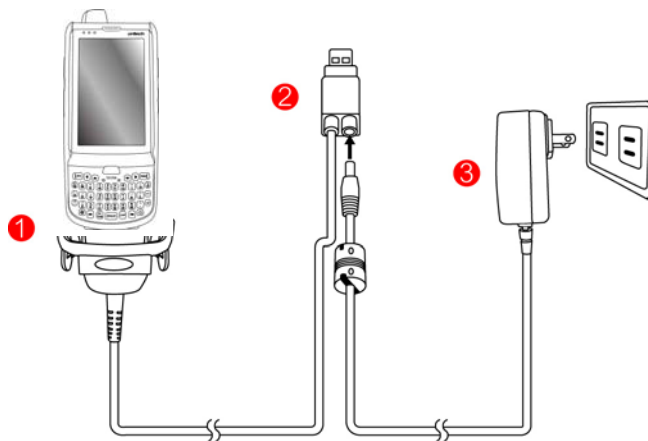

## Utiliser la carte de mémoire MicroSD

1. Enlevez les 2 vis du cache du port pour carte MicroSD et enlevez le cache.

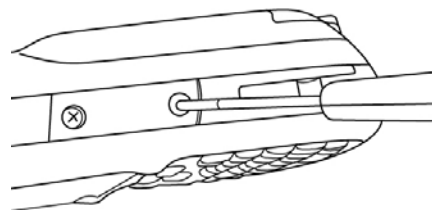

2. Insérer la carte MicroSD dans le compartiment comme le montre le dessin.

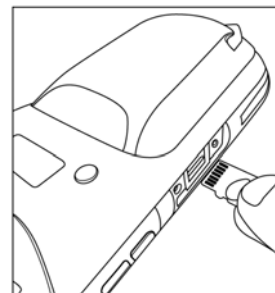

## Utiliser la carte SIM

PA690 a un espace pour la carte GPRS SIM à l'intérieur du compartiment de pile.

**PRÉCAUTION :** Avant d'installer la carte SIM, réserver vos données sauvegardées pour éviter la perte de données à cause de la faible charge de pile.

1. Enlever le capot de pile et la pile principale.
2. Glisser la couverture de la carte SIM vers la droite et relâcher le verrouillage.

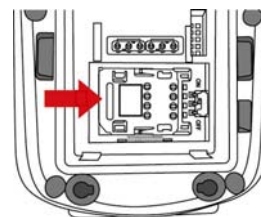

3. Ouvrir le couvercle avec le pouce.

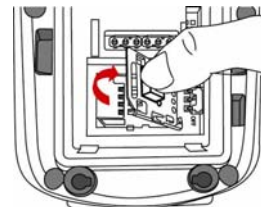

4. Insérer la carte SIM dans le couvercle avec le coin entaillé vers le haut, et les contacts de la carte SIM vers le bas.

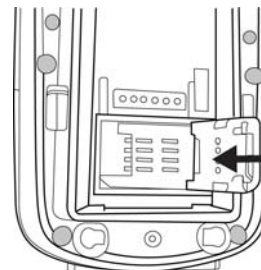

5. Presser le couvercle sur la fente, et glissez le vers la gauche afin de verrouiller la carte SIM.

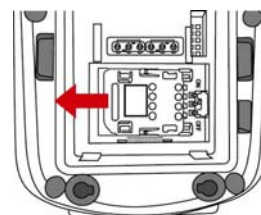

6. Réinstaller la pile dans le compartiment et fermer le capot de pile.

## Le clavier et la fonction des touches



**Clavier numérique**

























**Clavier Qwerty**

Touche	Description	Touche	Description
	Touche marche/arrêt		Touche pour sortir
	Touche pour valider		Touche effacement arrière
	Touche de tabulation		Touche de fonction
	Touche alpha, qui passe du mode numérique au mode de l'accès alphabétique		Touche Windows
	Touches alphanumériques		Touche pour terminer un appel téléphonique
	Touche de réponse		Touche de curseur gauche
	Touche de curseur droite		Touche de curseur vers le haut
	Touche de curseur vers le bas		



























Lorsque PA690 amorce, le default est le Mode Numérique on. Lorsque vous passez au mode Alpha, le default est le Mode CAPS off. Utilisez la Touche alpha pour passer au mode CAPS.

## Utiliser les touches fonction











### Pour le clavier Qwerty

Touche	Description	Touche	Description
 + 	Réglage du rétro-éclairage du clavier	 + 	Réglage du rétro-éclairage de l'écran
 + 	Diminue la luminosité du rétro-éclairage de l'écran	 + 	Augmente la luminosité du rétro-éclairage de l'écran
 + 	Touche programmable 2	 + 	Touche programmable 1
 + 	FIN DE LA COMMUNICATION	 + 	PARLER
 + 	Réglages du scanner	 + 	Lancement du gestionnaire des tâches
 + 	Informations sur l'appareil	 + 	Gestion de l'alimentation





### Pour le clavier numérique

Touche	Description	Touche	Description
 + 	Calibration	 + 	Réglage du rétro-éclairage de l'écran
 + 	Réglage du rétro-éclairage du clavier	 + 	Gestion de l'alimentation
 + 	Informations sur l'appareil	 + 	Touche programmable 1
 + 	Touche programmable 2	 + 	Diminue la luminosité du rétro-éclairage de l'écran
 + 	Augmente la luminosité du rétro-éclairage de l'écran	 + 	PARLER
 + 	FIN DE LA COMMUNICATION	 + 	Lancement du gestionnaire des tâches
 + 	Réglages du scanner		

## Utiliser les touches Alpha

Touche	Alpha Off	Alpha On	
		CAPS Off	CAPS On
	0	Espace, @, \$, ", 0	Espace, @, \$, ", 0
	1	+, -, \, %, 1	+, -, \, %, 1
	2	a, b, c, 2	A, B, C, 2
	3	d, e, f, 3	D, E, F, 3
	4	g, h, i, 4	G, H, I, 4
	5	j, k, l, 5	J, K, L, 5
	6	m, n, o, 6	M, N, O, 6
	7	p, q, r, 7	P, Q, R, 7
	8	t, u, v, 8	T, U, V, 8
	9	w, x, y, z, 9	W, X, Y, Z, 9
	#	, ; ! . /	, ; ! . /

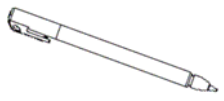
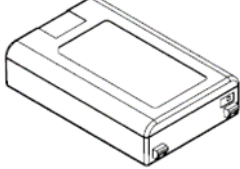
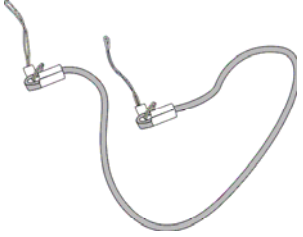
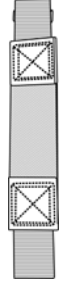
## PA690 产品介绍与附件包

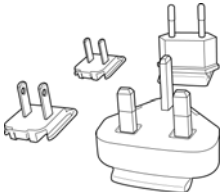
			
PA690 终端		手册 CD	
			
触针		电池	
			
弹性触针绳		腕带	
			
电源适配器	插头		

版权所有 2011 Unitech Electronics Co., Ltd. 保留所有权利。Unitech 是 Unitech Electronics Co., Ltd. 的注册商标。

**Unitech electronics co., ltd.**

5F., No.135, Ln. 235, Baoqiao Rd., Xindian Dist., New Taipei City 231, Taiwan (R.O.C.)

• Tel: + 886 2 89121122 • Fax: +886 2 89121810 • website: www.ute.com

## PA690 正面视图与右视图

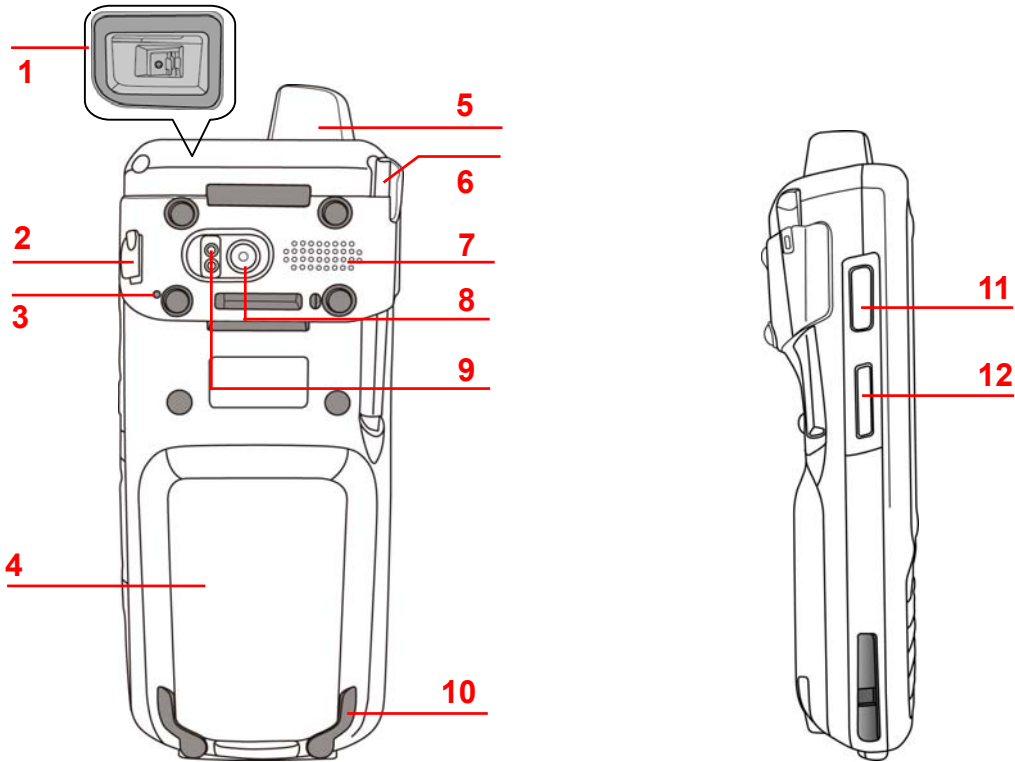

- |           |            |
|-----------|------------|
| 1 LED 指示灯 | 7 电源按钮     |
| 2 LCD 触摸屏 | 8 通用接口     |
| 3A 麦克风    | 9 扫描器触发按钮  |
| 3B 重置按钮   | 10 静音/振动按钮 |
| 4 受话器     | 11 相机按钮    |
| 5 扫描按钮    | 12 记忆卡槽    |
| 6 键盘      |            |

## 第一次开启 PA690

第一次使用设备之前，必须充电 16 小时，方可使用。您现在可以启动设备来校准显示屏，学习一些基本的输入笔的使用方法，并设置系统时区、日期和时间。

版权所有 2011 Unitech Electronics Co., Ltd. 保留所有权利。Unitech 是 Unitech Electronics Co., Ltd. 的注册商标。

Unitech electronics co., ltd.

5F., No.135, Ln. 235, Baoqiao Rd., Xindian Dist., New Taipei City 231, Taiwan (R.O.C.)

• Tel: + 886 2 89121122 • Fax: +886 2 89121810 • website: www.ute.com

开机按钮 

按住面板前面的电源按钮开启设备。

## PA690 背面视图与左视图

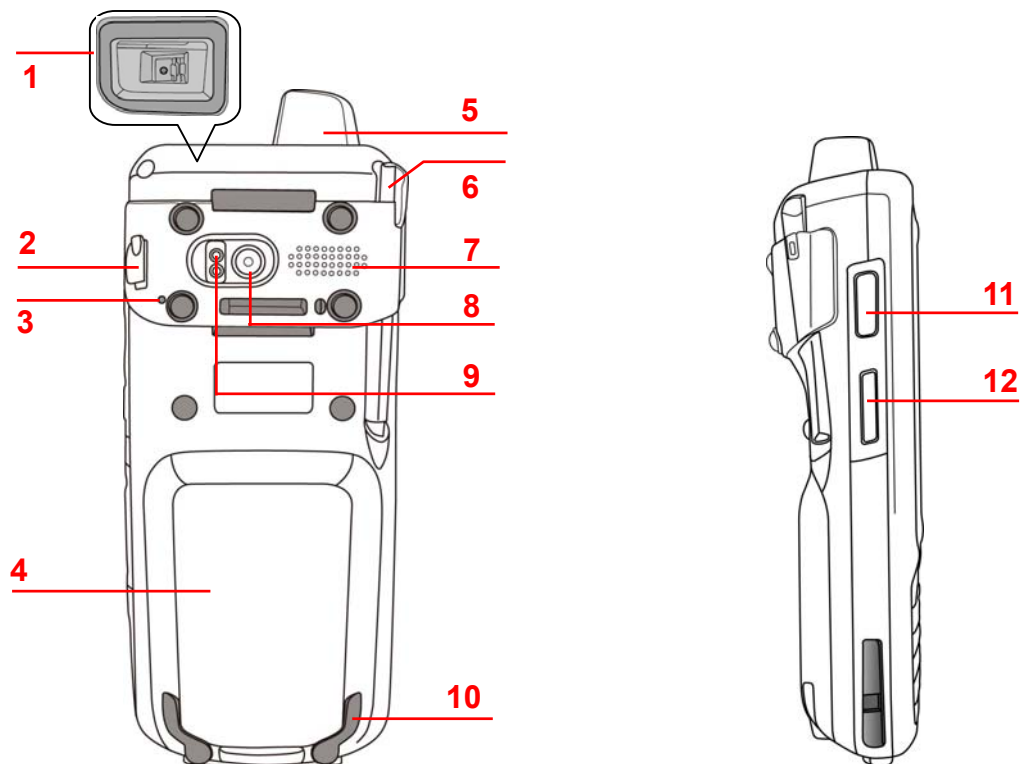

1 条形码扫描窗口

2 耳机插孔

3 麦克风

4 电池仓

5 天线

6 触针

7 扬声器

8 5 (百万像素) M/AF 相机

9 LED 闪光灯

10 电池仓锁闩

11 扫描器触发按钮

12 音量大/小

## 安装电池

1. 按箭头所示方向滑动并提起两边锁闩以打开电池仓。

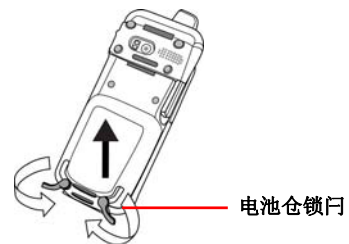

2. 使用写手笔尖将备用电池开关拨到“ON”位置，打开备用电池。

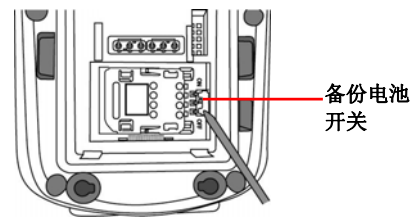

3. 滑动并且安装电池组，确保电池接点与电池仓中的接点对齐。



4. 拉出塑料片直至电池被安放到位。

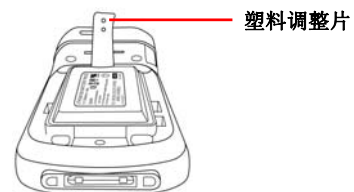

5. 重新安装好电池仓盖，如图所示向下压电池仓锁闩并滑动回原位。

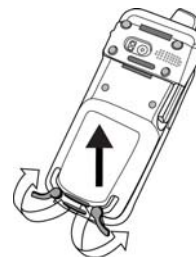

**注意：**请确保闩紧电池仓盖，否则您将无法正常开启设备。

## 电池充电

**警告：** 电池充电前，应将备份电池开关打开，启用备份电池。备份电池如果没有充足电量，您所输入的数据有可能无法正常储存。

1. 按下并按住 **USB** 充电电缆上的连接器按钮，并将其连接到 **PA690** (1)。
2. 将 **AC** 转接器电缆插入 **USB** 充电电缆上的电源插孔(2)。
3. 将 **AC** 转接器电线连接到电源插座(3)。

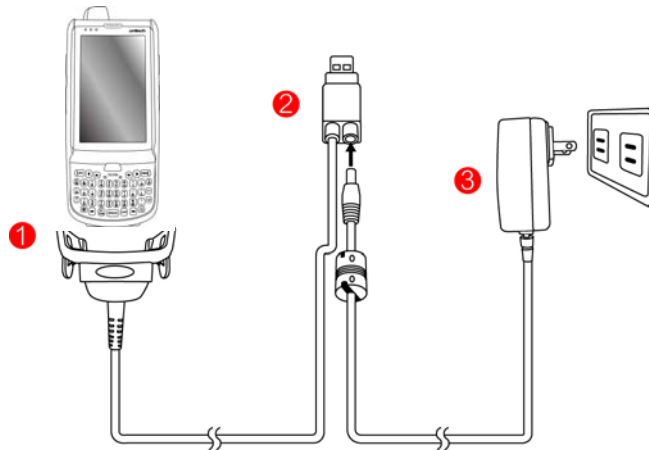

## 使用 **MicroSD** 存储卡

1. 拧下 **MicroSD** 卡插槽盖上的两个螺丝，同时取下插槽盖。

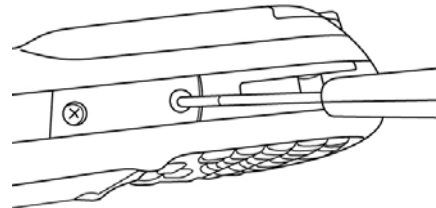

2. 将 **MicroSD** 卡如图所示有倒角的一端插入。

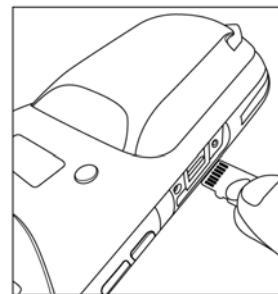

## 使用 SIM 卡

PA690 的电池仓具有一个 GPRS SIM 卡插槽。

**警告：** 插入 SIM 卡之前，请先备份您的数据以防因备份電池電量不足而导致数据流失。

1. 打开电池盖，并取下电池组。
2. 将 SIM 卡插槽盖往右滑，松开插槽盖。

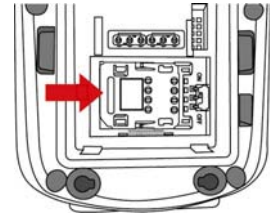

3. 用拇指拨开插槽盖。

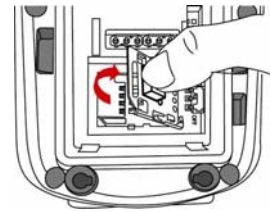

4. 将 SIM 卡插入插槽盖，如右图所示将 SIM 卡缺角朝上、SIM 卡金属接点面朝下。

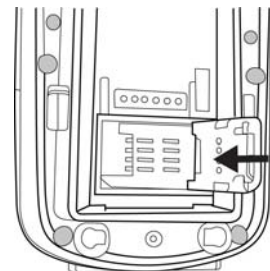

5. 向下按插槽盖并往左滑，以固定住 SIM 卡。

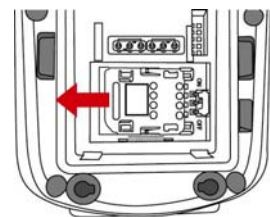

6. 放回电池组并重新安装好电池仓盖。

## 按键盘和功能按钮

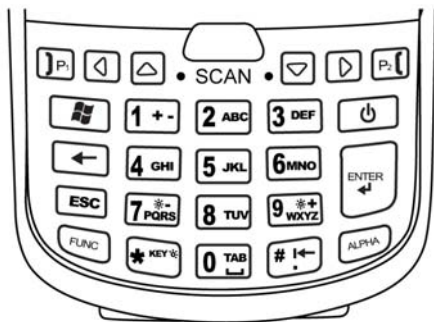

数字键盘



Qwerty (标准)键盘

按键	描述	按键	描述
	电源键		退出键
	确认键		退格键
	制表键		功能键
	Alpha 键，切换数字与字母输入模式		开始菜单键
	数字/字母键		挂断键
	应答键		向左光标键
	向右光标键		向上光标键
	向下光标键		

PA690 启用时，默认为数字模式，可通过“Alpha”键切换到“字母模式” (Alpha Mode)，默认为小写状态。利用 Alpha 键可切换到大写模式(CAPS Mode)。

## 功能键的使用

### 用于 Qwerty (标准) 键盘

按键	描述	按键	描述
 + 	键盘背景光切换	 + 	屏幕背景光切换
 + 	屏幕背光亮度降低	 + 	屏幕背光亮度提高
 + 	热键 2	 + 	热键 1
 + 	结束通话	 + 	通话
 + 	扫描器设定	 + 	执行任务管理器
 + 	设备信息	 + 	电源管理

### 用于数字键盘

按键	描述	按键	描述
 + 	校准	 + 	屏幕背景光切换
 + 	键盘背景光切换	 + 	电源管理
 + 	设备信息	 + 	热键 1
 + 	热键 2	 + 	屏幕背光亮度降低
 + 	屏幕背光亮度提高	 + 	通话
 + 	结束通话	 + 	执行任务管理器
 + 	扫描器设定		











版权所有 2011 Unitech Electronics Co., Ltd. 保留所有权利。Unitech 是 Unitech Electronics Co., Ltd. 的注册商标。

Unitech electronics co., ltd.

5F., No.135, Ln. 235, Baoqiao Rd., Xindian Dist., New Taipei City 231, Taiwan (R.O.C.)

• Tel: + 886 2 89121122 • Fax: +886 2 89121810 • website: www.ute.com

## Alpha键的使用

按键	Alpha 关闭	Alpha 开启	
		CAPS 关闭	CAPS 开启
	0	Space, @, \$, ", 0	Space, @, \$, ", 0
	1	+, -, \, %, 1	+, -, \, %, 1
	2	a, b, c, 2	A, B, C, 2
	3	d, e, f, 3	D, E, F, 3
	4	g, h, i, 4	G, H, I, 4
	5	j, k, l, 5	J, K, L, 5
	6	m, n, o, 6	M, N, O, 6
	7	p, q, r, 7	P, Q, R, 7
	8	t, u, v, 8	T, U, V, 8
	9	w, x, y, z, 9	W, X, Y, Z, 9
	#	, ; ! . /	, ; ! . /

## PA690 產品簡介與配件組

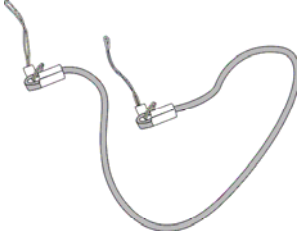
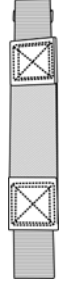
			
PA690 終端機		手冊光碟	
			
輸入筆		電池	
			
彈性輸入筆吊繩		手帶	
			
電源變壓器	插頭		

版權所有 2011 Unitech Electronics Co., Ltd. 保留所有權利。Unitech 是 Unitech Electronics Co., Ltd. 的註冊商標。

Unitech electronics co., ltd.

5F., No.135, Ln. 235, Baoqiao Rd., Xindian Dist., New Taipei City 231, Taiwan (R.O.C.)

• Tel: + 886 2 89121122 • Fax: +886 2 89121810 • website: www.ute.com

## PA690 前視圖與右視圖

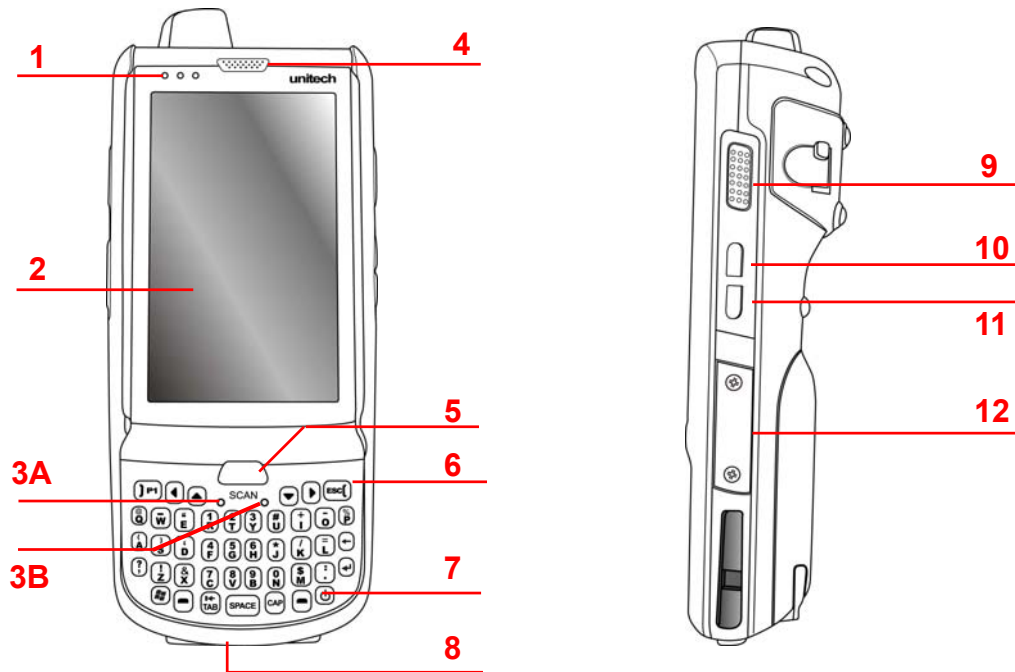

- |             |            |
|-------------|------------|
| 1 LED 指示燈   | 7 電源按鈕     |
| 2 LCD 觸控式螢幕 | 8 通用連接器    |
| 3A 麥克風      | 9 掃描器觸發按鈕  |
| 3B 重開機按鈕    | 10 靜音／震動按鈕 |
| 4 收音器       | 11 相機按鈕    |
| 5 掃描按鈕      | 12 記憶卡插槽   |
| 6 按鍵盤       |            |

## 首次開啟 PA690

在您将装置进行初次充电大约 16 小时之后，装置就准备好可供使用。您现在可以启动装置，调整校准显示萤幕，学习一些输入笔的基本使用方法，并且设定系统时区、日期和时间。

Copyright 2011 Unitech Electronics Co., Ltd.，版權所有。Unitech 是 Unitech Electronics Co., Ltd. 的註冊商標。

Unitech electronics co., ltd.

5F., No.135, Ln. 235, Baoqiao Rd., Xindian Dist., New Taipei City 231, Taiwan (R.O.C.)

• Tel: + 886 2 89121122 • Fax: +886 2 89121810 • website: www.ute.com

電源開啟按鈕 

按一下前面板上的電源按鈕，開啟裝置的電源。

## PA690 後視圖與左視圖

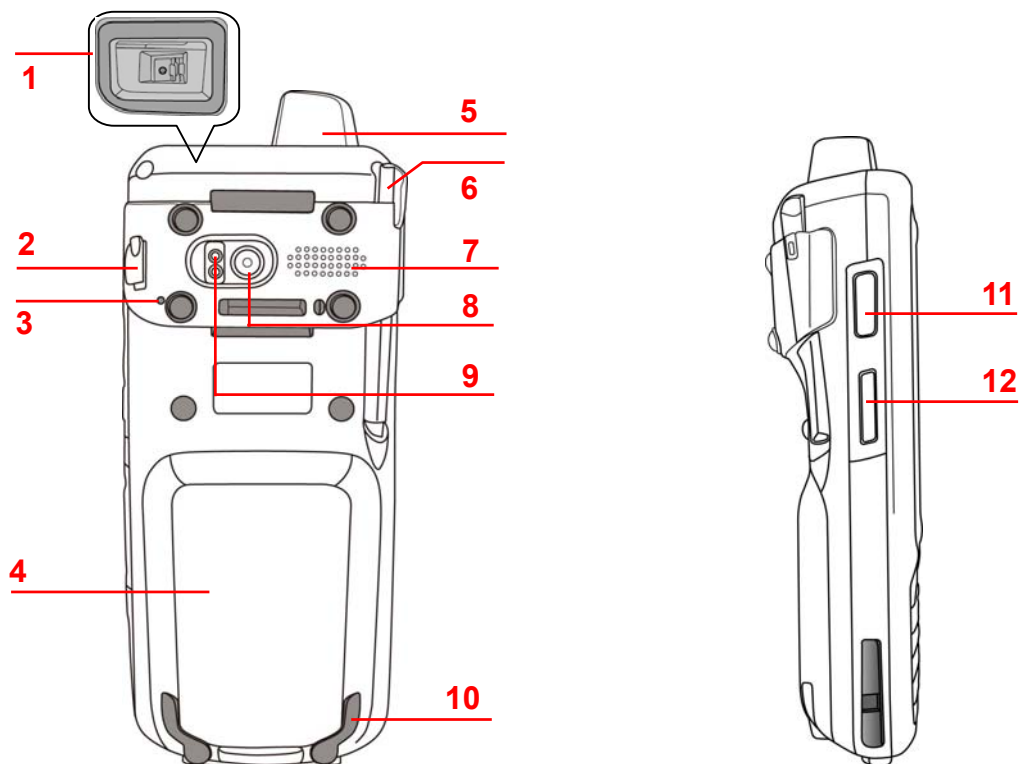

1 條碼掃描器視窗

2 耳機孔

3 麥克風

4 電池室

5 天線

6 輸入筆

7 喇叭

8 5M/AF 相機

9 LED 閃光燈

10 電池室卡門

11 掃描器觸發按鈕

12 音量大/小

## 安裝電池

1. 按照箭頭方向滑動卡門，向上提起電池蓋，開啟電池室。

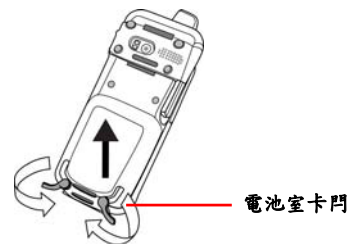

2. 用輸入筆將備份電池開關往上推到「ON」的位置，啟用備份電池。

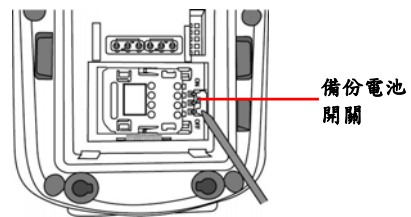

3. 滑入並置入電池組，確認電池的接點對齊電池室中的接點。

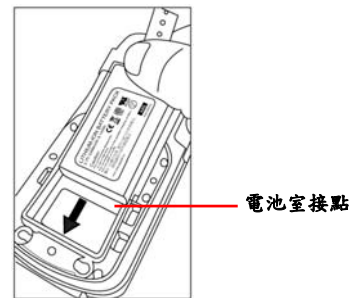

4. 拉動塑膠調整片，直到電池卡入定位。

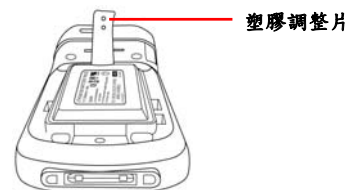

5. 重新安裝電池蓋，如圖示下壓電池室卡門並滑動回原位。

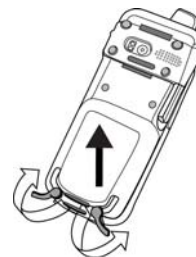

**注意：**請確認電池蓋是否完全閉緊，否則將無法正常開機。

## 電池充電

**警告：**為電池充電前，應先開啟備份電池的開關。備份電池如果沒有充足電量，您所輸入的資料有可能無法正常儲存。

1. 按住 USB 充電電源線兩邊的按鈕，將它連接 PA690 (1)。
2. 將 AC 變壓器電源線插入 USB 充電電源線的電源插孔(2)。
3. 將 AC 變壓器電源線插入電源插座(3)。

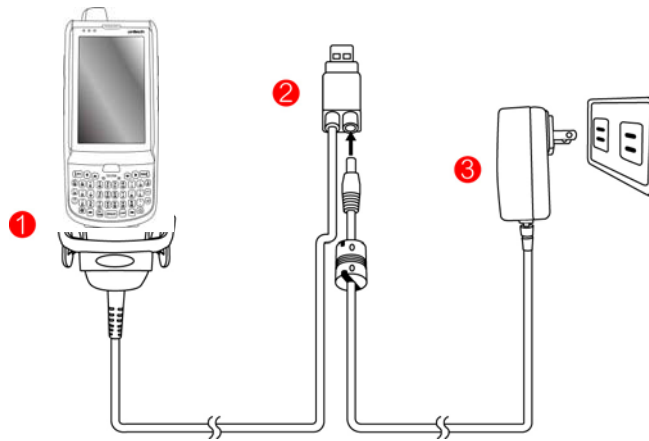

## 使用 MicroSD 記憶卡

1. 拆下 MicroSD 插槽蓋上的兩顆螺絲，並取下護蓋。

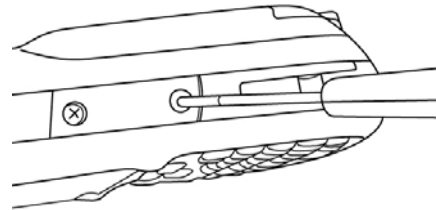

2. 將 MicroSD 卡如圖所示有缺角的一端插入。

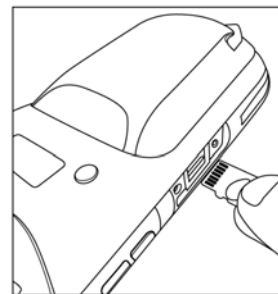

## 使用 SIM 卡

PA690 的電池室備有 GPRS SIM 卡的插槽。

**警告：** 插入 SIM 卡之前，請先備份您的資料以防因備份電池電量不足而導致資料流失。

1. 打開電池蓋，取出電池。
2. 將 SIM 卡插槽蓋往右滑，鬆開插槽蓋。

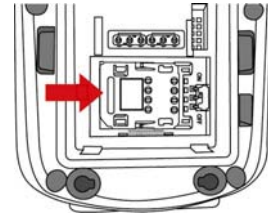

3. 用拇指拉開插槽蓋。

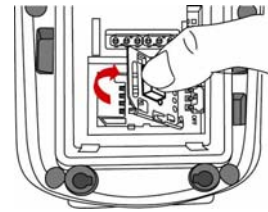

4. 將 SIM 卡缺角朝上、金屬接點朝下插入插槽蓋。

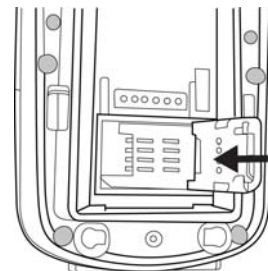

5. 壓下插槽蓋並往左滑，固定住 SIM 卡。

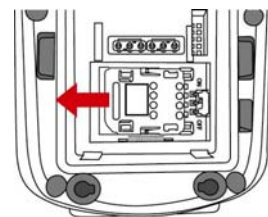

6. 置回電池並重新安裝好電池蓋。

## 鍵盤和功能按鈕

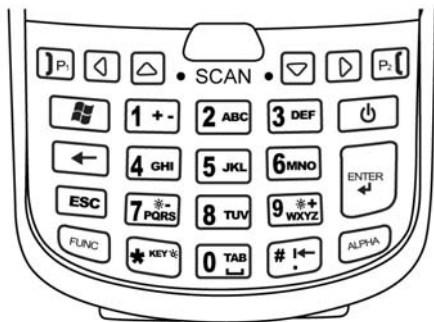

數字鍵盤



























字母鍵盤

按鍵	說明	按鍵	說明
	電源鍵		退出鍵
	輸入鍵		退格鍵
	定位鍵		功能鍵
	Alpha 鍵，可在數字和字母輸入模式間切換		視窗鍵
	數字/字母鍵		掛斷鍵
	答覆鍵		左方向鍵
	右方向鍵		上方向鍵
	下方向鍵		

當啟動 PA690 後，預設是開啟成數字模式(Numeric Mode)。當您切換成文數字模式(Alpha Mode)的時候，預設是關閉大寫模式(CAPS Mode)。請利用 Alpha 鍵切換成大寫模式(CAPS)。

## 功能鍵的使用











### 適用於字母鍵盤

按鍵	說明	按鍵	說明
 + 	切換鍵盤背光	 + 	切換螢幕背光
 + 	調低螢幕背光亮度	 + 	調高螢幕背光亮度
 + 	功能鍵 2	 + 	功能鍵 1
 + 	結束通話	 + 	通話
 + 	掃描器設定	 + 	執行工作管理員
 + 	裝置資訊	 + 	電源管理





### 適用於數字鍵盤

按鍵	說明	按鍵	說明
 + 	校正	 + 	切換螢幕背光
 + 	切換鍵盤背光	 + 	電源管理
 + 	裝置資訊	 + 	功能鍵 1
 + 	功能鍵 2	 + 	調低螢幕背光亮度
 + 	調高螢幕背光亮度	 + 	通話
 + 	結束通話	 + 	執行工作管理員
 + 	掃描器設定		

## Alpha鍵的使用

按鍵	Alpha 關閉	Alpha 開啟	
		CAPS 關閉	CAPS 開啟
	0	Space, @, \$, ", 0	Space, @, \$, ", 0
	1	+, -, \, %, 1	+, -, \, %, 1
	2	a, b, c, 2	A, B, C, 2
	3	d, e, f, 3	D, E, F, 3
	4	g, h, i, 4	G, H, I, 4
	5	j, k, l, 5	J, K, L, 5
	6	m, n, o, 6	M, N, O, 6
	7	p, q, r, 7	P, Q, R, 7
	8	t, u, v, 8	T, U, V, 8
	9	w, x, y, z, 9	W, X, Y, Z, 9
	#	, ; ! . /	, ; ! . /

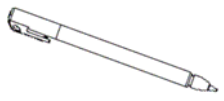
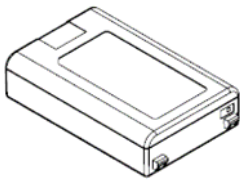
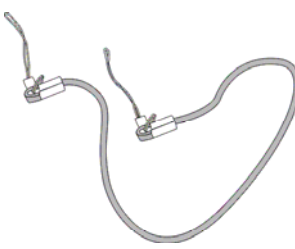
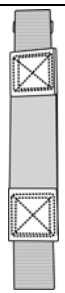
## PA690 製品の紹介とアクセサリキット

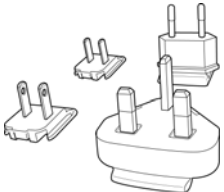
			
PA690 ターミナル		マニュアル CD	
			
スタイラス		バッテリー	
			
伸縮性のあるスタイラス用紐		ハンドストラップ	
			
電源アダプタ	プラグ		

## PA690 前面図と右視図

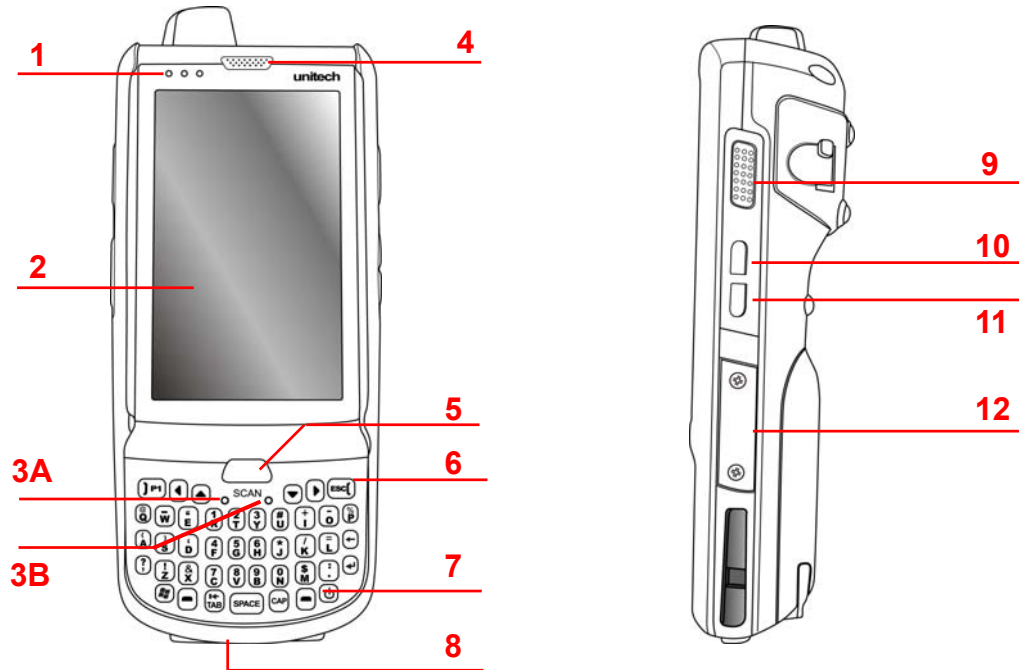

- |             |                |
|-------------|----------------|
| 1 LEDインジケータ | 7 電源ボタン        |
| 2 LCD タッチ画面 | 8 汎用コネクター      |
| 3A マイクロホン   | 9 スキャナビボタン     |
| 3B 再起動ボタン   | 10 ミュート/振動ボタン  |
| 4 受話器       | 11 カメラボタン      |
| 5 スキャンボタン   | 12 メモリーカードスロット |
| 6 キーパッド     |                |

## PA690 の初回起動方法

デバイスを最初に使用するには、16 時間デバイスを充電する必要があります。デバイスを起動してディスプレイの調整、ペンの使用方法の学習、およびシステムのタイムゾーン、日付、および時刻を設定することができます。

Copyright 2011 Unitech Electronics Co., Ltd. 版權所有。Unitech は Unitech Electronics Co., Ltd の登録商標です。

Unitech electronics co., ltd.

5F., No.135, Ln. 235, Baoqiao Rd., Xindian Dist., New Taipei City 231, Taiwan (R.O.C.)

• Tel: + 886 2 89121122 • Fax: +886 2 89121810 • website: www.ute.com

電源オンボタン 

前面パネルの電源ボタンを押してデバイスをつけられます。

## PA690 背面図と左視図

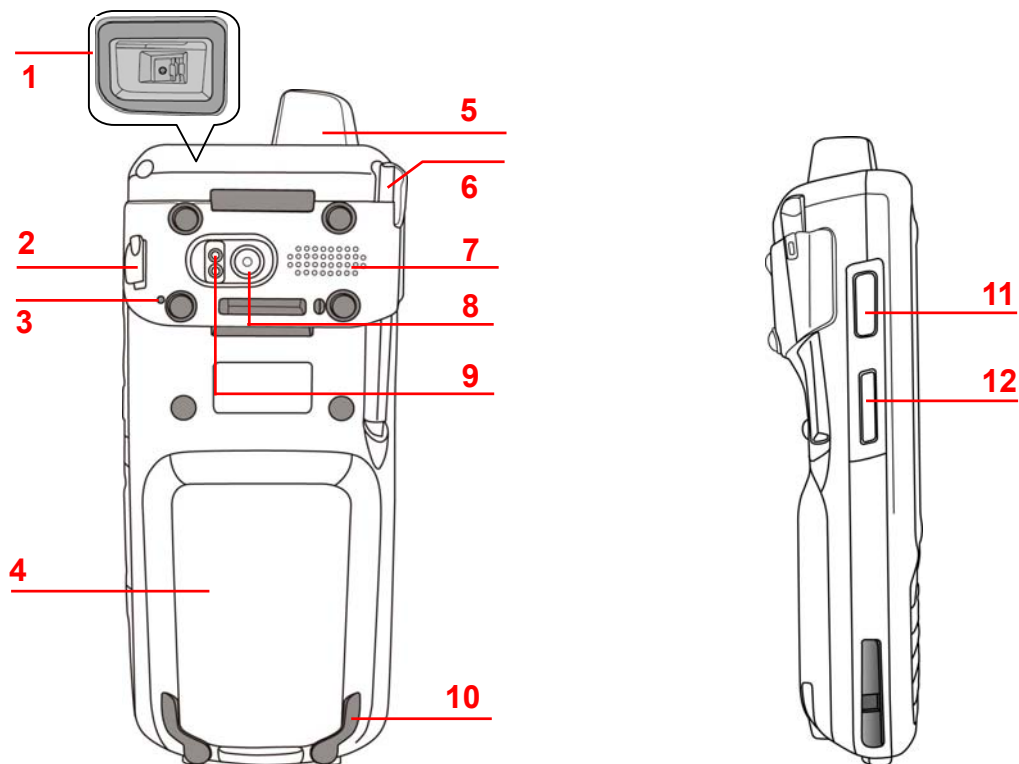

- |   |                 |    |              |
|---|-----------------|----|--------------|
| 1 | バーコードスキャナーウィンドウ | 7  | スピーカー        |
| 2 | ヘッドホンジャック       | 8  | 5M/AF カメラ    |
| 3 | マイクロホン          | 9  | LED フラッシュライト |
| 4 | 電池室             | 10 | スライドタブ       |
| 5 | アンテナ            | 11 | スキャナビボタン     |
| 6 | スタイラス           | 12 | 音量上げ・下げ      |

## 電池の取り付け方

1. 矢印の方向にスライドさせて、カバーを上方向に開けます。

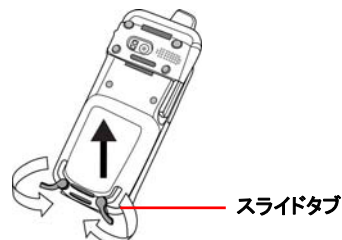

2. バックアップバッテリーをオンにするには、スタイラスを利用してバックアップバッテリースイッチを「ON」の位置に引き上げます。

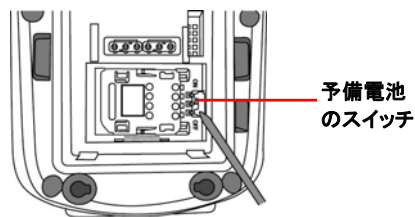

3. 電池パックをスライドして固定し、電池の接点が電池室の接点と合わせることを確認してください。



4. 電池が固定するまでプラスチックタブを引いてください。

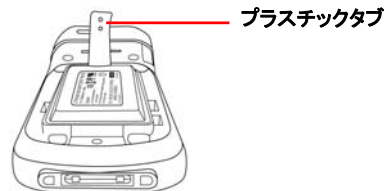

5. 電池室のカバーを装着し、図に示すようにタブを下に押し後ろにスライドしながら所定の位置に戻します。

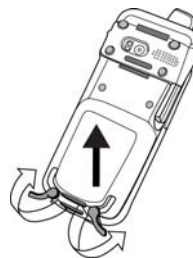

**メモ:** 電池室のカバーがきちんとはまっていないと、電源が入らない場合があります。

## 電池の充電

**注意:** 電池を充電する前に、予備電池のスイッチをオンにして、予備電池を充電して下さい。予備電池が十分に充電されていないと、入力したデータがきちんと保存されない場合があります。

1. USB 充電ケーブル両端のリリースボタンを押したまま PA690 に接続します(1)。
2. USB 充電ケーブルの電源差込み口に AC アダプターケーブルを差し込みます(2)。
3. AC アダプターの電源をコンセントに差し込みます(3)。

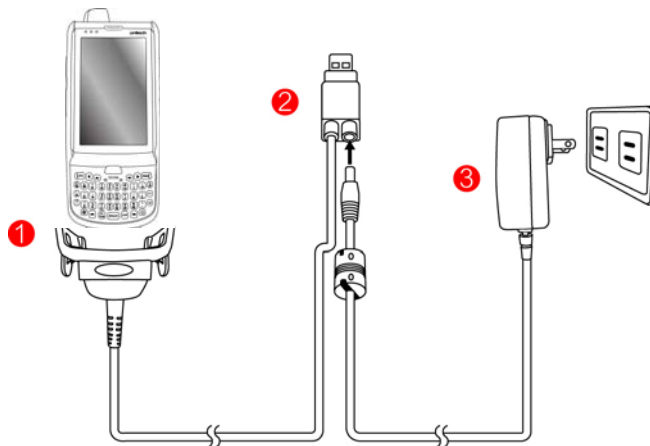

## MicroSD メモリーカードの使い方

1. MicroSD スロットのシールド上の 2 個のネジを取り外し、シールドを取り外します。

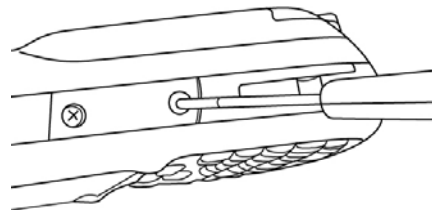

2. 図のように角がギザギザになった MicroSD カードを挿入します。

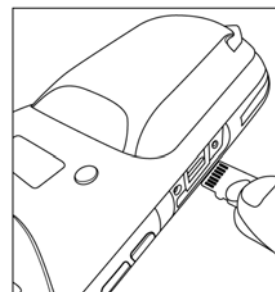

## SIM カードの使い方

PA690 の電池室には GPRS SIM カードの取り付けトレイが内蔵されています。

**注意:** SIM カードを挿入するにあたり、予備電池の電量不足によりデータ流出の恐れがありますので、必ずデータのバックアップを行ってください。

1. 電池カバーとメイン電池一を取り出します。
2. SIM カードのトレイカバーを右に向けて押し開きます。

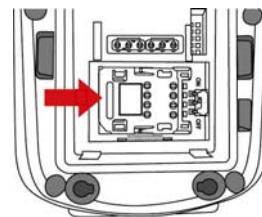

3. 指でカバーを引き開けます。

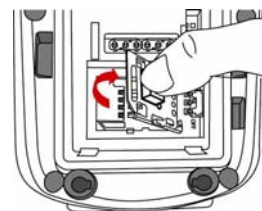

4. 下図のようにカバーの裏側に SIM カードの切り欠きを上向きに、SIM カードの金属接点を下向きに入れます。

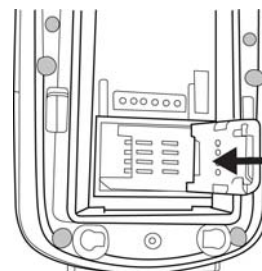

5. カバーを戻し、左に向けてスライドして、SIM カードを固定します。

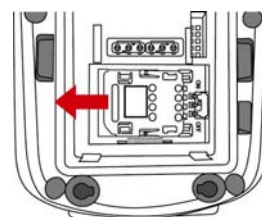

6. 電池を戻し、リアカバーをしてください。

## キーボードとファンクションボタン



数字キーボード



























Qwerty キーボード

キー	説明	キー	説明
	電源キー		エスケープキー
	エンターキー		バックスペースキー
	タブキー		ファンクションキー
	アルファキー、数字とアルファベットの切り替え		Windows キー
	数字/アルファベットキー		終話キー
	応答キー		左カーソルキー
	右カーソルキー		上カーソルキー
	下カーソルキー		













PA690 を起動すると、デフォルト状態は数字モードがオンになります。アルファモードに切り替えると、デフォルト状態はCAPSモードがオフになります。CAPSに切り替えるには、アルファ キーを使用してください。

## ファンクションキーの使い方

### Qwerty キーボード用

キー	説明	キー	説明
 + 	キーパッドバックライトの切り替え	 + 	スクリーンバックライトの切り替え
 + 	スクリーンバックライトの輝度を下げます	 + 	スクリーンバックライトの輝度を上げます
 + 	ソフトキー 2	 + 	ソフトキー 1
 + 	終話キー	 + 	通話
 + 	スキャナの設定	 + 	タスク管理
 + 	デバイス情報	 + 	電源管理





### 数字キーボード用

キー	説明	キー	説明
 + 	調整	 + 	スクリーンバックライトの切り替え
 + 	キーパッドバックライトの切り替え	 + 	電源管理
 + 	デバイス情報	 + 	ソフトキー 1
 + 	ソフトキー 2	 + 	スクリーンバックライトの輝度を下げます
 + 	スクリーンバックライトの輝度を上げます	 + 	通話
 + 	終話キー	 + 	タスク管理
 + 	スキャナの設定		

## アルファキーの使い方

キー	アルファオフ	アルファオン	
		CAPS オフ	CAPS オン
	0	Space, @, \$, “, 0	Space, @, \$, “, 0
	1	+, -, \, %, 1	+, -, \, %, 1
	2	a, b, c, 2	A, B, C, 2
	3	d, e, f, 3	D, E, F, 3
	4	g, h, i, 4	G, H, I, 4
	5	j, k, l, 5	J, K, L, 5
	6	m, n, o, 6	M, N, O, 6
	7	p, q, r, 7	P, Q, R, 7
	8	t, u, v, 8	T, U, V, 8
	9	w, x, y, z, 9	W, X, Y, Z, 9
	#	, ; ! . /	, ; ! . /

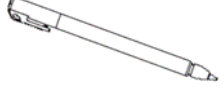
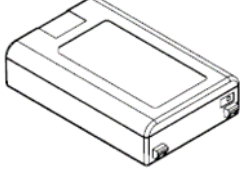
## PA690 제품 소개 & 악세사리 키트

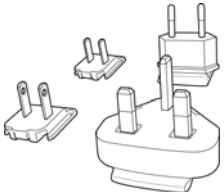
			
PA690 터미널		매뉴얼 CD	
			
터치 펜		배터리	
			
고무 스타일러스 줄		핸드 스트랩	
			
전원 어댑터	플러그		

## PA690 전면 및 우측면 보기

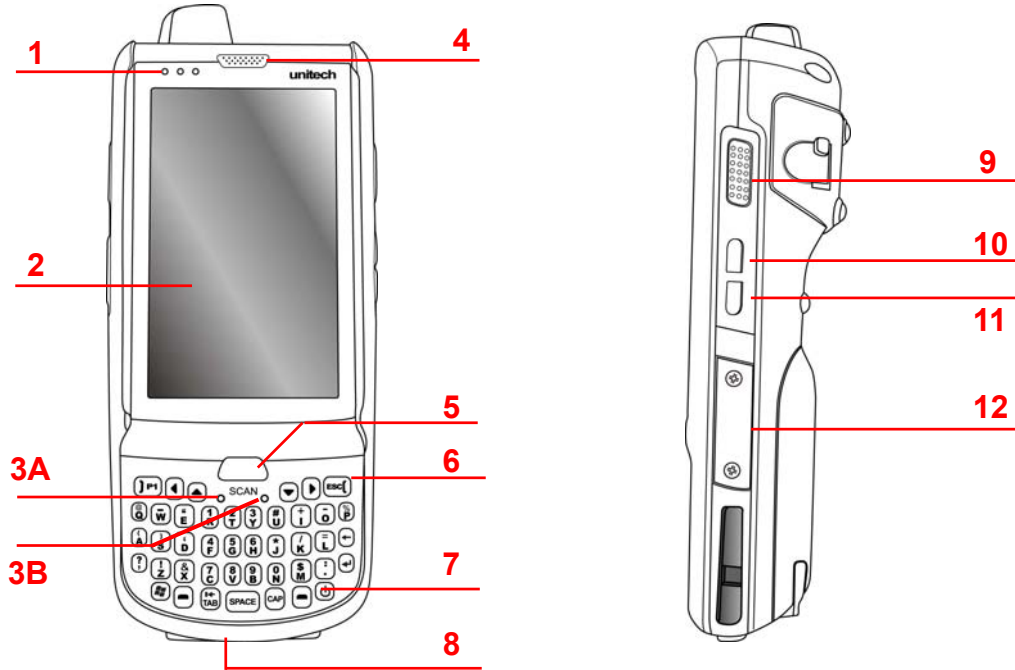

- |             |                |
|-------------|----------------|
| 1 LED 표시등   | 7 전원 버튼        |
| 2 LCD 터치스크린 | 8 범용 커넥터       |
| 3A 마이크      | 9 스캐너 트리거 버튼   |
| 3B 리셋 버튼    | 10 음소거 / 진동 버튼 |
| 4 수신기       | 11 카메라 버튼      |
| 5 스캔 버튼     | 12 메모리 카드 슬롯   |
| 6 키패드       |                |

## 처음으로 PA690 켜기

초기에 장치를 약 16 시간 충전한 후 사용할 수 있습니다. 고객님의 지금 장치를 가동하여 스크린을 조정하고 기본 입력방식을 배울 수 있으며 시스템 시간 대, 날짜와 시간을 설정할 수 있습니다.

저작권 2011 Unitech Electronics Co., Ltd. 모든 권리는 저작권자의 소유입니다.  
Unitech 는 Unitech Electronics (주)의 등록 상표입니다.

Unitech electronics co., ltd.

5F., No.135, Ln. 235, Baoqiao Rd., Xindian Dist., New Taipei City 231, Taiwan (R.O.C.)

• Tel: + 886 2 89121122 • Fax: +886 2 89121810 • website: www.ute.com

전원 켜기 버튼 

장치 정면의 전원 버튼을 눌러 장치 전원을 가동합니다.

## PA690 후면 및 좌측면 보기

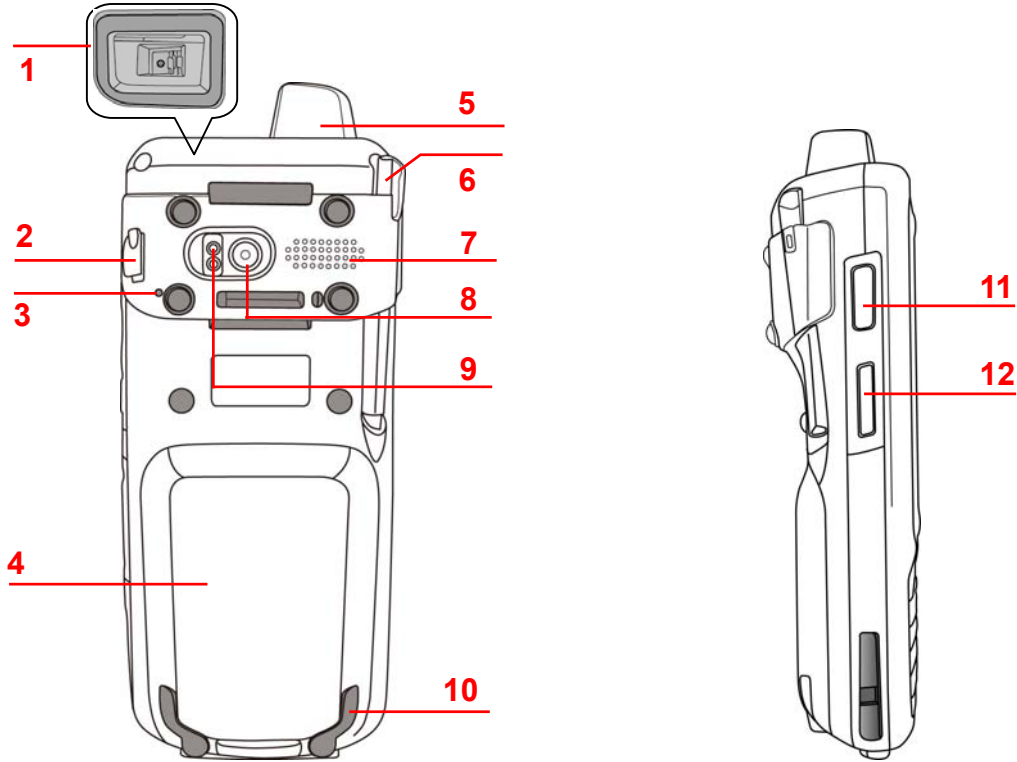

1 바코드 스캐너 창

2 헤드폰 단자

3 마이크

4 배터리 격납부

5 안테나

6 터치 펜

7 스피커

8 5M/AF 카메라

9 LED 플래쉬

10 배터리 격납부 탭

11 스캐너 트리거 버튼

12 볼륨 올리기/낮추기

## 배터리 설치하기

1. 양쪽 면의 탭을 그림에서 화살표로 표시된 방향으로 돌린 다음 배터리 덮개를 위로 올려 벗깁니다.

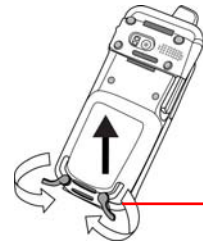

배터리 격납부 탭을

2. 백업 배터리를 켜기 위해 스타일러스를 사용하여 "ON" 위치로 백업 배터리 스위치를 밀어 올립니다.

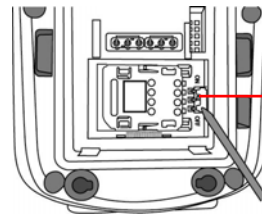

백업 배터리 스위치

3. 배터리 팩을 슬라이드 하여 위치시키고, 배터리 연결이 위치에 맞게 제대로 되었는지 확인하십시오.

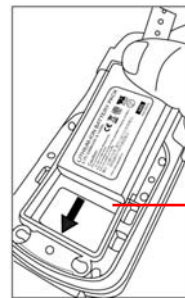

배터리 단자 접촉면

4. 플라스틱 탭을 배터리가 장착될 때까지 당깁니다.

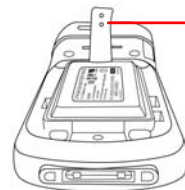

플라스틱 탭

5. 배터리 격납부 커버를 그림처럼 위치시키고 탭을 눌러서 격납부 커버를 완전히 잠겨주십시오.

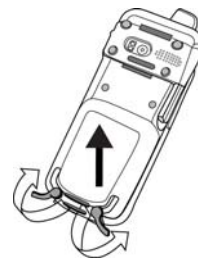

**주의:** 배터리격납부 덮개가 단단히 닫기지 않으면 정상적으로 장치를 가동할 수 없습니다.

## 배터리 충전하기

**경고:** 배터리를 충전하기 전에 백업 배터리 스위치를 아래로 내리십시오.  
내장 백업 배터리가 충분히 충전될 때까지 입력한 데이터가  
올바르게 저장되지 않을 수도 있습니다.

1. USB 충전 전원코드 양편의 버튼을 누르며 PA690 에 연결합니다 (1).
2. AC 어댑터 케이블을 USB 충전 케이블의 전원 잭에 연결하십시오 (2).
3. AC 어댑터 전원 코드를 전원 콘센트에 연결합니다 (3).

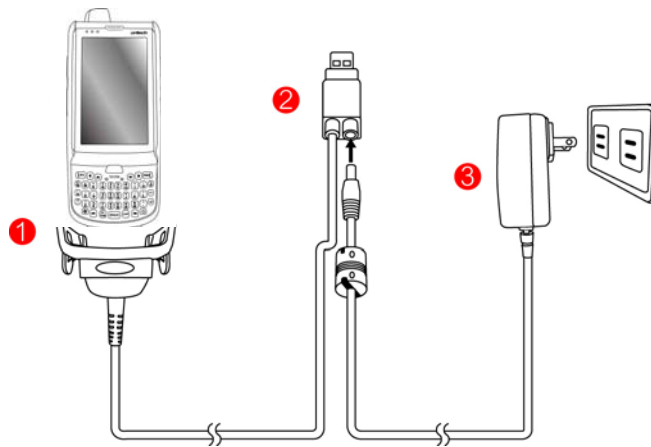

## MicroSD 메모리 카드 사용하기

1. MicroSD 슬롯 쉘드의 나사 두  
개를 제거하고 쉘드를  
제거합니다.

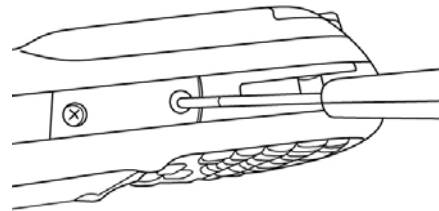

2. 그림처럼 MicroSD 카드의 경사진 귀퉁이 부  
위를 삽입합니다.

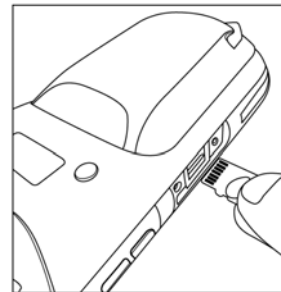

## SIM 카드 사용

PA690 의 배터리격납부에 GPRS SIM 카드 슬롯이 있습니다.

**경고:** 배터리 양이 부족하여 데이터를 잃는 경우가 발생하지 않도록 SIM 카드를 장착하기 전에는 데이터를 먼저 백업해야 합니다.

1. 배터리 커버와 주 배터리를 제거하십시오.
2. SIM 카드 슬롯 덮개를 오른쪽으로 밀어 슬롯 덮개의 잠금을 해제합니다.

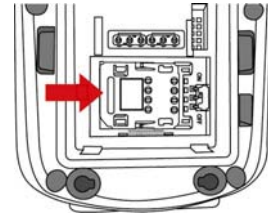

3. 엄지로 커버를 당겨 엽니다.

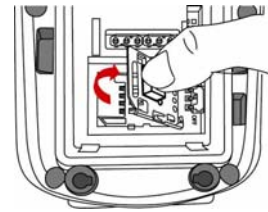

4. SIM 카드의 한쪽 모서리가 절단된 면이 위로 향하고 SIM 카드의 금속 접점이 바닥면으로 향하게 커버 안에 삽입합니다.

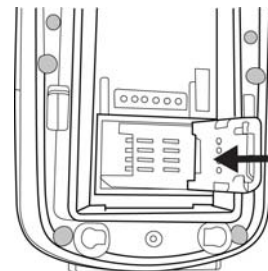

5. 슬롯 덮개를 올리고 오른쪽으로 밀어 SIM 카드를 고정합니다.

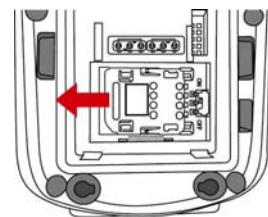

6. 배터리를 장착한 후 배터리 덮개를 닫습니다.

저작권 2011 Unitech Electronics Co., Ltd. 모든 권리는 저작권자의 소유입니다.  
Unitech 는 Unitech Electronics (주)의 등록 상표입니다.

Unitech electronics co., ltd.

5F., No.135, Ln. 235, Baoqiao Rd., Xindian Dist., New Taipei City 231, Taiwan (R.O.C.)

• Tel: + 886 2 89121122 • Fax: +886 2 89121810 • website: www.ute.com

## 키패드 및 기능 단추

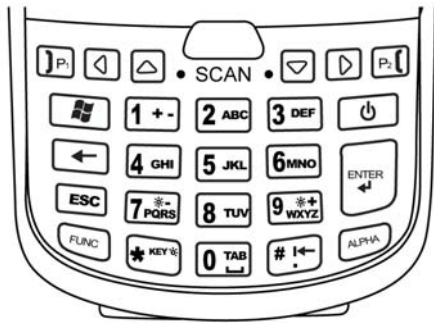

숫자 키보드



쿼터 키보드

키	설명	키	설명
	전원 키		ESC 키
	Enter 키		백스페이스 키
	탭 키		기능 키
	알파 키, 숫자와 영문자 입력 모드 전환		윈도우 키
~	영숫자 키		통화 끄기 키
	응답 키		커서 왼쪽으로 키
	커서 오른쪽으로 키		커서 아래로 키
	아래쪽		

























PA690 이 부팅될 때 기본 상태로 숫자 모드가 설정됩니다 . 알파 모드로 전환 하면기본 상태가 CAPS 모드 해제 상태로 설정됩니다. 알파 키 이용 해서 CAPS 로 전환할 수 있습니다.

## 기능 키의 사용

### 쿼터 키보드 용

키	설명	키	설명
 + 	키패드 백라이트 토글	 + 	스크린 백라이트 토글
 + 	스크린 백라이트 밝기 감소	 + 	스크린 백라이트 밝기 증가
 + 	소프트키 2	 + 	소프트키 1
 + 	통화 종료	 + 	통화
 + 	스캐너 설정	 + 	작업 관리자 실행
 + 	장치 정보	 + 	전원 관리

### 숫자 키패드 용

키	설명	키	설명
 + 	칼리브레이션	 + 	스크린 백라이트 토글
 + 	키패드 백라이트 토글	 + 	전원 관리
 + 	장치 정보	 + 	소프트키 1
 + 	소프트키 2	 + 	스크린 백라이트 밝기 감소
 + 	스크린 백라이트 밝기 증가	 + 	통화
 + 	통화 종료	 + 	작업 관리자 실행
 + 	스캐너 설정		











저작권 2011 Unitech Electronics Co., Ltd. 모든 권리는 저작권자의 소유입니다.  
Unitech 는 Unitech Electronics (주)의 등록 상표입니다.

Unitech electronics co., ltd.

5F., No.135, Ln. 235, Baoqiao Rd., Xindian Dist., New Taipei City 231, Taiwan (R.O.C.)

• Tel: + 886 2 89121122 • Fax: +886 2 89121810 • website: www.ute.com

알파 키의 사용

키	알파 Off	알파 On	
		CAPS Off	CAPS On
	0	Space, @, \$, ", 0	Space, @, \$, ", 0
	1	+, -, \, %, 1	+, -, \, %, 1
	2	a, b, c, 2	A, B, C, 2
	3	d, e, f, 3	D, E, F, 3
	4	g, h, i, 4	G, H, I, 4
	5	j, k, l, 5	J, K, L, 5
	6	m, n, o, 6	M, N, O, 6
	7	p, q, r, 7	P, Q, R, 7
	8	t, u, v, 8	T, U, V, 8
	9	w, x, y, z, 9	W, X, Y, Z, 9
	#	, ; ! . /	, ; ! . /

저작권 2011 Unitech Electronics Co., Ltd. 모든 권리는 저작권자의 소유입니다.  
Unitech 는 Unitech Electronics (주)의 등록 상표입니다.

Unitech electronics co., ltd.

5F., No.135, Ln. 235, Baoqiao Rd., Xindian Dist., New Taipei City 231, Taiwan (R.O.C.)

• Tel: + 886 2 89121122 • Fax: +886 2 89121810 • website: www.ute.com