

# PA690 Rugged Mobile Computer

- PA690 -

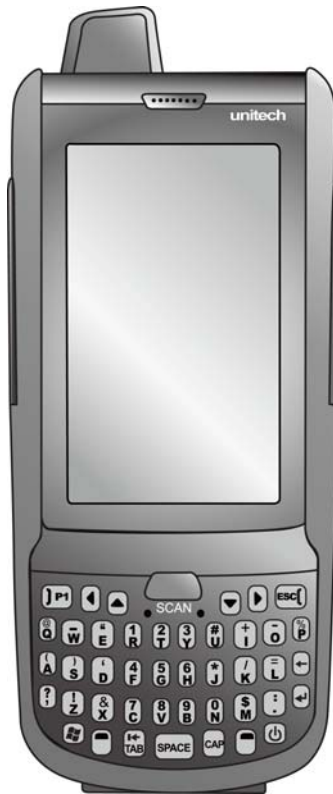

## **User's Manual**

---

**400854G Version 1.0**



## About This Manual

This manual explains how to install, operate and maintain the PA690 Rugged Mobile Computer.

No part of this publication may be reproduced or used in any form, or by any electrical or mechanical means, such as photocopying, recording, or information storage and retrieval systems, without permission in writing from the manufacturer. The material in this manual is subject to change without notice.

© Copyright 2011 Unitech Electronics Co., Ltd. All rights reserved.

Unitech global website address: <http://www.unitech-adc.com>

Bluetooth is a registered trademark of Bluetooth SIG.



Microsoft, Windows and ActiveSync are either registered trademarks or trademarks of Microsoft Corporation. Other product names mentioned in this manual may be trademarks or registered trademarks of their respective companies and are hereby acknowledged.



Unitech is a member of Oracle Embedded Software Licensing Program.

## Regulatory Compliance Statements

---

### FCC Warning Statement

This equipment has been tested and found to comply with the limits for a Class B digital device, pursuant to part 15 of the FCC rules. These limits are designed to provide reasonable protection against harmful interference in a residential installation. This equipment generates, uses and can radiate radio frequency energy and, if not installed and used in accordance with the instructions, may cause harmful interference with radio communications. However, there is no guarantee that interference will not occur in a particular installation. If this equipment does cause harmful interference with radio or television reception, which can be determined by turning the equipment off and on, the user is encouraged to try to correct the interference by one or more of the following measures:

- Reorient or relocate the receiving antenna.
  - Increase the separation between the equipment and receiver.
  - Connect the equipment into an outlet on a circuit different from that to which the receiver is connected.
  - Consult the dealer or an experienced radio/TV technician for help.
1. This Transmitter must not be co-located or operating in conjunction with any other antenna or transmitter.
  2. This equipment complies with FCC RF radiation exposure limits set forth for an uncontrolled environment. To maintain compliance with FCC RF exposure requirements, avoid direct contact to the transmitting antenna during transmitting.
  3. Any changes or modifications (including the antennas) made to this device that are not expressly approved by the manufacturer may void the user's authority to operate the equipment.

### FCC Label Statement

This device complies with part 15 of the FCC rules. Operation is subject to the following two conditions:

1. This device may not cause harmful interference, and
2. This device must accept any interference received, including interference that may cause undesired operation.

## RF Radiation Exposure Statement

For body contact during operation, this phone has been tested and meets FCC RF exposure guidelines when used with an accessory that contains no metal and that positions the handset a minimum of 1.5 cm from the body. Use of other accessories may not ensure compliance with FCC RF exposure guidelines.

## Canadian Compliance Statement

This Class B Digital apparatus meets all requirements of the Canadian Interference-Causing Equipment Regulations.

Cet appareil numérique de la classe B respecte les exigences du Règlement sur le matériel brouilleur du Canada.

## European Conformity Statement

Declaration of Conformity with regards to the R&TTE 1999/5/EC and EMC 89/336/ EEC directives.

## RoHS Statement



This device conforms to RoHS (Reduction Of Hazardous Substances) European Union regulations that set maximum concentration limits on hazardous materials used in electrical and electronic equipment.

## TaiwanNCC Warning Statement

交通部電信總局低功率電波輻射性電機管理辦法 (930322)

根據交通部低功率管理辦法規定：

第十二條 經型式認證合格之低功率射頻電機，非經許可，公司、商號或使用者均不得擅自變更頻率、加大功率或變更原設計之特性及功能。

第十四條 低功率射頻電機之使用不得影響飛航安全及干擾合法通信；經發現有干擾現象時，應立即停用，並改善至無干擾時方得繼續使用。前項合法通信，指依電信法規定作業之無線電通信。

低功率射頻電機須忍受合法通信或工業、科學及醫療用電波輻射性電機設備之干擾。

## Laser Information

---

The Unitech PA690 series is certified in the U.S. to conform to the requirements of DHHS/CDRH 21CFR Subchapter J and to the requirements of IEC 825-1. Class II and Class 2 products are not considered to be hazardous. The PA690 series contains internally a Visible Laser Diode (VLD) whose emissions do not exceed the maximum limits as set forth in the above regulations. The scanner is designed so that there is no human access to harmful laser light during normal operation, user maintenance or prescribed service operations.

The laser safety warning label required by the DHHS/IEC for the PA690 series' optional laser scanner module is located on the memory compartment cover, on the back of the unit.

**CAUTION!** Use of controls or adjustments or performance of procedures other than those specified herein may result in hazardous laser light. Use of optical instruments with the scanner, including binoculars, microscopes, and magnifying glasses, with will increase eye damage. This does not include eyeglasses worn by the user.

## Battery Notices

---

The PA690 is equipped with a Lithium-Ion battery pack and a Ni-Mh backup battery. Both batteries will discharge after an extended period of no use.

When both batteries are discharged, recharge the unit for 12 hours in order to fully charge the main battery and backup battery. Recharge the PA690 battery by doing the following:

1. Plug the USB charging cable into the PA690 and plug the 5V/3A AC-DC adapter into the power jack of the USB charging cable.
2. Place the PA690 into the docking station and plug the 5V/3A AC-DC adapter into the power jack of the docking station.

If the main battery is removed, the backup battery ensures the data on SDRAM is safe for up to 2 hours. To prevent data loss, do not leave the PA690 uncharged with the main battery removed for an extended period. See the *Charging the Battery* unit on for more details.

**Note:** To guarantee optimal performance, it is advised that rechargeable batteries be replaced every year, or when 500 charge/discharge cycles are achieved. It is normal that the battery balloons or expands beyond one year or the maximum of 500 cycles. Although it does not cause harm, it cannot be used again and must be disposed of according to the location's safe battery disposal procedures.

If the performance decrease is greater than 20% in a Lithium-Ion battery, the battery is at the end of its life cycle. Do not continue to use, and ensure the battery is disposed of properly.

The length of time that a battery lasts depends on the battery type and how the device is used. Conserve the battery life by doing the following:

- Avoid frequent full discharges because this places additional strain on the battery. Several partial discharges with frequent recharges are better than a full discharge. Recharging a partially charged lithium-Ion battery does not cause harm because there is no memory.
- Keep the lithium-Ion battery cool. Avoid a hot car. For prolonged storage, keep the battery at a 40% charge level.
- Do not leave the lithium-Ion battery discharged and unused for an extended period because the battery will wear out and the longevity of the battery will be at least half of the one with frequent recharges.

## Battery charge notice

It is important to consider the environment temperature when the Lithium-Ion battery pack is charged. Charging is most efficient at normal room temperature or in a slightly cooler environment. It is essential that batteries are charged within the stated range of 0°C to 40°C. Charging batteries outside of the specified range could damage the batteries and shorten their charging life cycle.

**CAUTION!** Do not charge batteries at a temperature lower than 0°C. This will increase the internal resistance to cause heat and make the batteries unstable and unsafe. Please use a battery temperature detecting device for a charger to ensure a safe charging temperature range.

## Storage and safety notice

Although charged Lithium-Ion batteries may be left unused for several months, their capacity may be depleted due to build up of internal resistance. If this happens they will require recharging prior to use. Lithium-Ion batteries may be stored at temperatures between -20°C to 60°C, however they may deplete more rapidly at higher temperatures. It is recommended to store batteries at room temperature.

## Warranty

---

The following items covered under the Unitech Limited Warranty are free from defects during normal use:

- PA690 – 1-year limited warranty.
- Lithium-Ion battery – 6-month limited warranty.

Warranty becomes void if equipment is modified, improperly installed or used, damaged by accident or neglect, or if any parts are improperly installed or replaced by the user.

Use only the adapter supplied. Using the wrong adapter may damage the unit and will void the warranty.

# Table of Contents

## Preface

<b>About This Manual</b> .....	<b>i</b>
Regulatory Compliance Statements .....	ii
<i>FCC Warning Statement</i> .....	<i>ii</i>
<i>FCC Label Statement</i> .....	<i>ii</i>
<i>RF Radiation Exposure Statement</i> .....	<i>iii</i>
<i>Canadian Compliance Statement</i> .....	<i>iii</i>
<i>European Conformity Statement</i> .....	<i>iii</i>
<i>RoHS Statement</i> .....	<i>iii</i>
<i>TaiwanNCC Warning Statement</i> .....	<i>iii</i>
Laser Information .....	iv
Battery Notices .....	iv
<i>Battery charge notice</i> .....	<i>v</i>
<i>Storage and safety notice</i> .....	<i>vi</i>
Warranty .....	vi

## Chapter 1

<b>Getting Started</b> .....	<b>1</b>
Introducing the PA690 .....	1
Features .....	2
PA690 Product Introduction & Accessory Kit .....	3
Tour of the PA690 .....	4
PA690 Front and Right View .....	4
PA690 Rear and Left View .....	5

Turning ON the PA690 for the First Time.....	5
Installing the Battery .....	6
Charging the Battery .....	7
Keypads and Function Buttons.....	9
<i>Using Function keys</i> .....	10
<i>Using Alpha keys</i> .....	11
<b>Chapter 2</b>	
<b>Using the Hardware .....</b>	<b>13</b>
Using the MicroSD Memory Card.....	13
<i>Inserting a Memory Card</i> .....	13
<i>Removing the Memory Card</i> .....	13
Using the SIM Card .....	13
<i>Inserting the SIM card</i> .....	14
Using the Barcode Laser Scanner.....	14
<b>Chapter 3</b>	
<b>Getting Connected.....</b>	<b>17</b>
Establishing Device-PC Connection.....	17
<i>Installing Microsoft ActiveSync</i> .....	17
<i>Connecting the Device to Your Computer</i> .....	18
WiFi Connection .....	19
<i>Using the Summit Utilities</i> .....	19
u-CenterMobile for Quick GPS Connection .....	22
<i>To Open u-CenterMobile</i> .....	22
<i>To Download Data</i> .....	23

## Chapter 4

<b>Barcode Scanner Programs</b> .....	<b>25</b>
Scanner Setting.....	25
Scan2Key.....	25
<i>Barcode Symbologies</i> .....	26
<i>Barcode Symbologies 2D</i> .....	27

## Chapter 5

<b>Advanced Settings</b> .....	<b>29</b>
Performing a Hardware Reset.....	29
<i>Performing a Warm Boot</i> .....	29
<i>Performing a Cold Boot</i> .....	29

## Appendix I

<b>System Specification</b> .....	<b>31</b>
-----------------------------------	-----------

## Appendix II

<b>Worldwide Support</b> .....	<b>33</b>
--------------------------------	-----------



## Getting Started

### Introducing the PA690

---

Thank you for purchasing the PA690 Rugged Mobile Computer.

The Unitech PA690 is a rugged handheld computer designed to empower your mobile workforce in today's aggressive business environment. As productivity and efficiency define the benchmark for success, the PA690 provides field-based workers with a host of data collection tools and a comprehensive wireless communication platform, all in a compact, durable and ergonomic form factor.



## Features

---

### Powerful system

- Microsoft Windows Mobile 6.5 operating system
- Marvell PXA320 processor with speed of up to 806 MHz

### System memory

- 256MB Mobile DDR
- 512MB NaNDFlash

### Display

- 3.8" TFT LCD touch screen
- 480 (W) x 800 (H) resolution (WVGA)
- Supports display rotation

### Communication

- USB 1.1 Host & Client
- Bluetooth 2.1 EDR (supports Bluetooth Printer, Bluetooth Modem, Bluetooth ActiveSync, and Bluetooth Headset)

### Camera

- Built-in 5M/AF camera with 2 flash LEDs

### Audio

- MIC
- Speaker
- Receiver (Headphone)

### Expansion slot

- MicroSD memory card slot, supporting up to 32GB

### Wireless connectivity

- WLAN, 802.11a/b/g
- WWAN, GSM : HSDPA
- WPAN, Class II, Bluetooth 2.1+EDR
- GPS/AGPS
- RFID/HF (Optional)
- RFID/UHF (Optional)





### User-friendly interface

- Special keys to launch particular applications and display the on-screen keyboard
- Keys for barcode scanning

### Barcode scanner engine

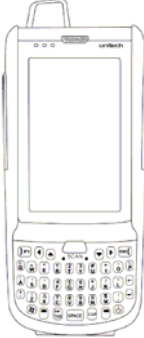
- 1D Engine (Optional)
- 2D Engine (Optional)

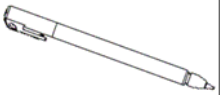
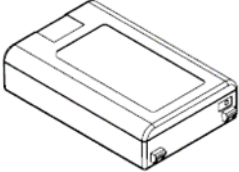
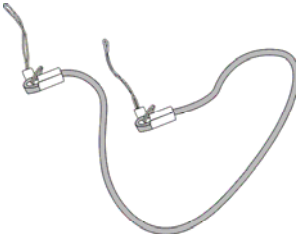
## PA690 Product Introduction & Accessory Kit

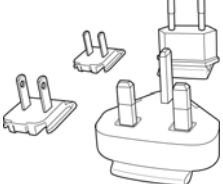
		
<p>PA690 Terminal</p>	<p>Manual CD</p>	
		
<p>Stylus</p>	<p>Battery</p>	
		
<p>Elastic Stylus String</p>	<p>Hand Strap</p>	
		
<p>Power Adaptor</p>	<p>Plugs</p>	

## Tour of the PA690

The following sections describe the main components and features of the PA690.

### PA690 Front and Right View

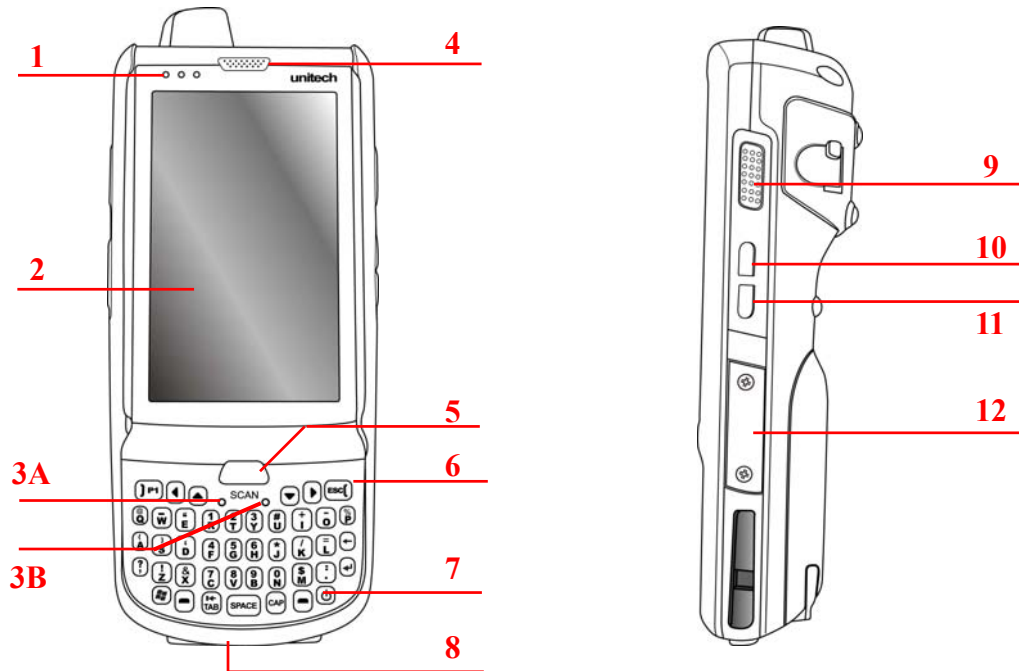

- |                    |                             |
|--------------------|-----------------------------|
| 1 LED indicators   | 7 Power button              |
| 2 LCD touch screen | 8 Universal connector       |
| 3A Microphone      | 9 Scanner trigger button    |
| 3B Reset button    | 10 Mute / vibration button* |
| 4 Receiver         | 11 Camera button            |
| 5 Scan button      | 12 Memory card slot         |
| 6 Keypad           |                             |

**\*Note:** If you just want Mute, hit the “+ -” button on the left side of the unit, and then select “OFF”. The unit will not mute, nor will it vibrate when you scan.

## PA690 Rear and Left View

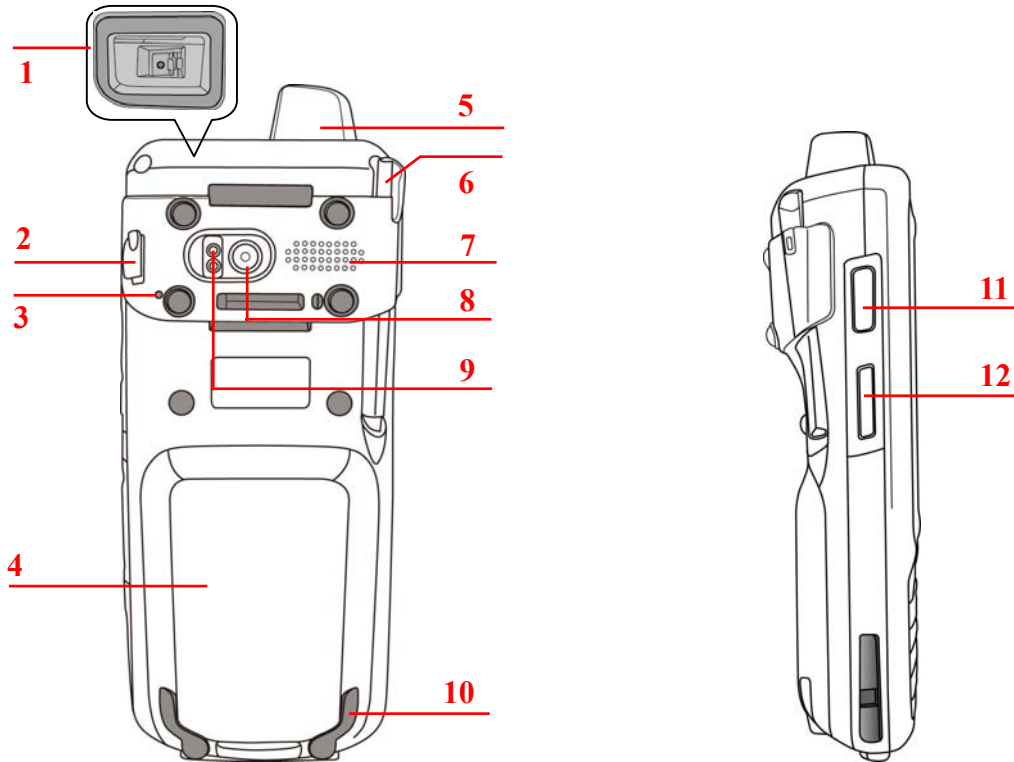

- |                          |                            |
|--------------------------|----------------------------|
| 1 Barcode scanner window | 7 Speaker                  |
| 2 Earphone jack          | 8 5M/AF camera             |
| 3 Microphone             | 9 LED flash light          |
| 4 Battery compartment    | 10 Battery compartment tab |
| 5 Antenna                | 11 Scanner trigger button  |
| 6 Stylus                 | 12 Volume up/down          |

## Turning ON the PA690 for the First Time

After you have initially charged your device for about 16 hours, the device is ready to be used. You can now start up your device. You can then calibrate the display, learn some basic stylus usage, and set up the system time zone, date and time.

Power-On Button 

Turn ON your device by pressing the power button on the front panel.

## Installing the Battery

**WARNING!** There is a risk of fire and burns if the battery pack is handled improperly. DO NOT disassemble, crush, puncture, short external contacts, or dispose the battery pack in fire or water. DO NOT attempt to open or service the battery pack. Dispose of used batteries according to local recycling guidelines in your area.

A backup battery cell is embedded into your device to prevent data loss when the main battery pack is removed or completely discharged. This backup battery will keep the data and system setting for up to 2 hours if the main battery is removed.

**NOTE:** To enable the backup battery cell to provide backup power supply, charge your device with the main battery pack for at least 16 hours.

**NOTE:** To power on the device properly, make sure to replace the battery compartment cover after installing the battery.

1. Open the battery compartment cover by sliding the tabs on both sides in the direction of the arrows shown and lift the cover up.

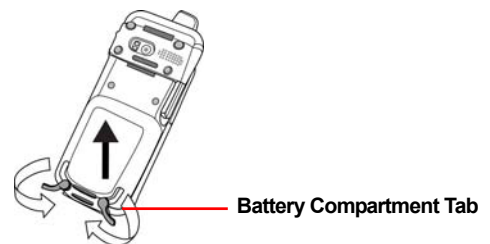

2. Push up the backup battery switch to the "ON" position by using a stylus to turn on the backup battery.

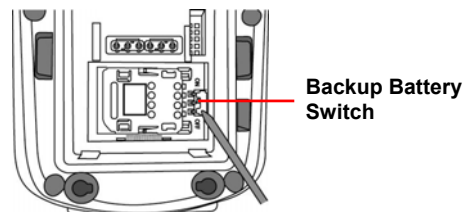

3. Slide and position the battery pack, making sure the battery contacts are aligned with the contacts in the compartment.

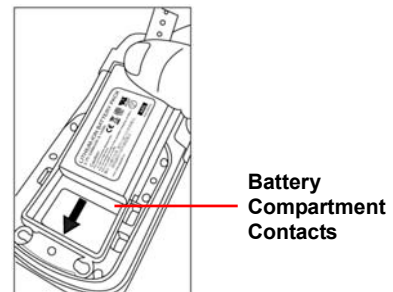

4. Use your thumb to snap the battery down for it to be in place.

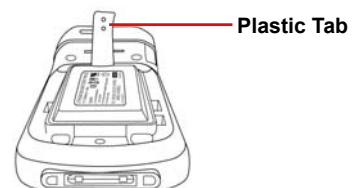

5. Replace the battery compartment cover by pushing down on the tabs and sliding them back into place as shown.

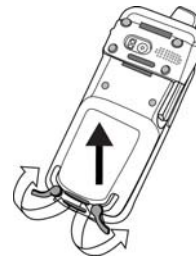

**NOTE:** Make sure the battery compartment cover is securely closed, or you may be unable to turn ON the terminal.

## Charging the Battery

---

Before using the terminal for the first time, you need to charge it for about 16 hours. After that, you can charge the terminal for 4 hours to recharge the battery to full capacity. Charge the terminal using the USB charging cable or the docking station.

**CAUTION:** Turn ON the backup battery switch before charging the battery. Data you entered may not be properly stored until the built-in backup battery has been adequately charged.

**CAUTION!** Operating the terminal for the first time without the AC adapter, and without fully charging the backup battery may result in loss of data stored in RAM memory. When the main battery is removed, the backup battery retains RAM data in memory for 2 hours. Please fully charge the backup battery to avoid data loss in RAM memory.

1. Press and hold the release button on both sides of the USB charging cable and connect it to the PA690 (1).
2. Plug the AC adapter cable into the power jack of the USB charging cable (2).

3. Plug the AC adapter cord into an electrical outlet (3).

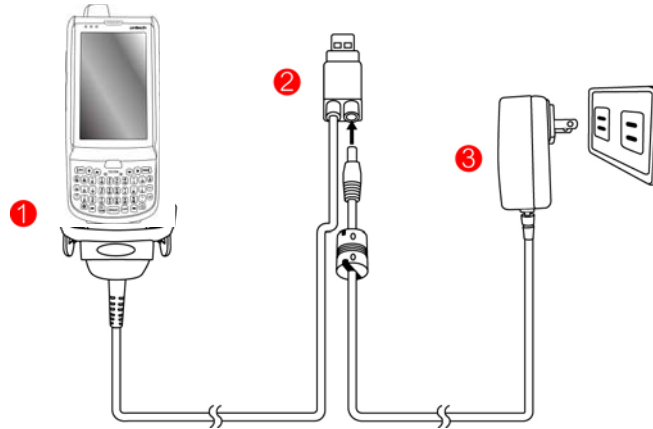

## Checking the LED status

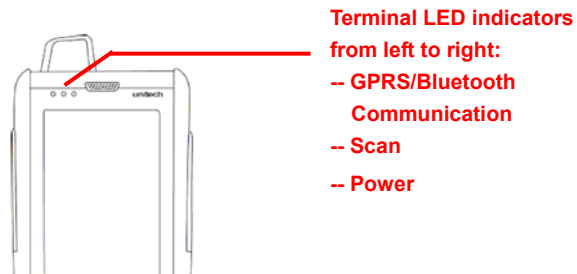

	LED	Status	Description
Terminal	GPRS/Bluetooth	Flashing Yellow	GPRS module is enabled.
		Flashing Blue	Bluetooth module is enabled.
	Scan	Solid Red	Ready for Reading
		Solid Green	Successful reading
	Power	Solid Red	Being charged
		Solid Green	Fully charged

## Checking the Battery Status

If the battery level becomes low in the course of normal use, a status icon appears on the device screen indicating low or very low battery status. In both cases, perform an ActiveSync operation to back up your data, and then recharge your device as soon as possible.

**CAUTION!** Once the device is shut down, you should recharge the device within 48 hours. Otherwise you will lose all data including files stored in the RAM memory.

## Keypads and Function Buttons

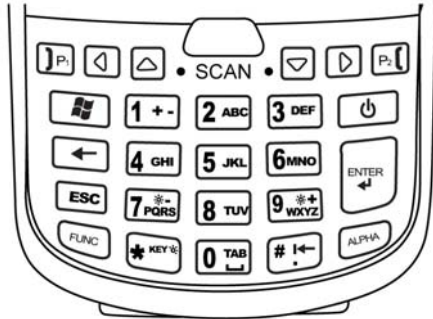

**Numeric Keypad**



























**Qwerty Keypad**

Key	Description	Key	Description
	Power key		Escape key
	Enter key		Backspace key
	Tab key		Function key
	Alpha key, toggle between numeric and alphabetic entry modes		Windows key
	Alphanumeric keys		Hang-off key
	Answer key		Left cursor key
	Right cursor key		Up cursor key
	Down cursor key		



























When the PA690 turns on, the numeric mode is on by default. When you toggle to alpha mode, the CAPS mode is off by default. Use the Alpha key to toggle to CAPS.

## Using Function keys











### For Qwerty Keypad

Key	Description	Key	Description
 + 	Keypad backlight toggling	 + 	Screen backlight toggling
 + 	Decrease screen backlight brightness	 + 	Increase screen backlight brightness
 + 	Softkey 2	 + 	Softkey 1
 + 	END TALK	 + 	TALK
 + 	Scanner setting	 + 	Task manager execution
 + 	Device information	 + 	Power management

### For Numeric Keypad

Key	Description	Key	Description
 + 	Calibration	 + 	Screen backlight toggling
 + 	Keypad backlight toggling	 + 	Power management
 + 	Device information	 + 	Softkey 1
 + 	Softkey 2	 + 	Decrease screen backlight brightness
 + 	Increase screen backlight brightness	 + 	TALK
 + 	END TALK	 + 	Task manager execution
 + 	Scanner setting		

## Using Alpha keys

Key	Alpha Off	Alpha On	
		CAPS Off	CAPS On
	0	Space, @, \$, “, 0	Space, @, \$, “, 0
	1	+, -, \, %, 1	+, -, \, %, 1
	2	a, b, c, 2	A, B, C, 2
	3	d, e, f, 3	D, E, F, 3
	4	g, h, i, 4	G, H, I, 4
	5	j, k, l, 5	J, K, L, 5
	6	m, n, o, 6	M, N, O, 6
	7	p, q, r, 7	P, Q, R, 7
	8	t, u, v, 8	T, U, V, 8
	9	w, x, y, z, 9	W, X, Y, Z, 9
	#	, ; ! . /	, ; ! . /



## Using the Hardware

### Using the MicroSD Memory Card

PA690 has an expansion slot compatible with a range of MicroSD memory cards, which are primarily used to back up or transfer files and data.

#### Inserting a Memory Card

1. Remove the two screws on the MicroSD slot shield and remove the shield.
2. Insert the MicroSD card with the notched corner as shown.

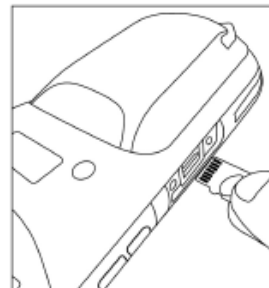
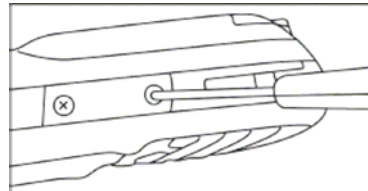

3. Push the card into the slot until you feel the MicroSD card click into place.
4. Screw the MicroSD compartment cover back into place.

#### Removing the Memory Card

1. Remove the two screws from the MicroSD compartment shield and remove the shield.
2. Press the card in and release. The card pops out.
3. Remove the card from the slot.

### Using the SIM Card

The PA690 has a slot for a GPRS SIM card inside the battery compartment.

**CAUTION!** Before installing the SIM card, please backup your data to prevent data loss because of a low backup battery.

## Inserting the SIM card

1. Remove the battery compartment cover and the main battery.
2. Slide the cover of the SIM card slot to the right to release the latch.

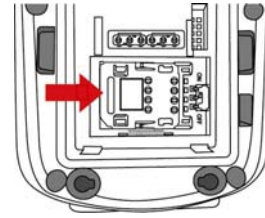

3. Pull open the cover with thumb.

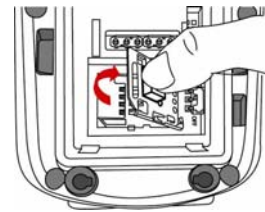

4. Insert the SIM card into the cover with the notched corner up, the contact side of the SIM card facing down.

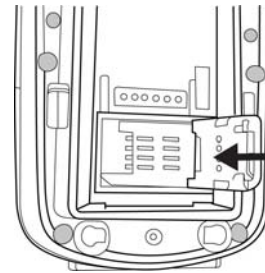

5. Close the cover over the slot, and then slide the cover to the left to lock the SIM card.

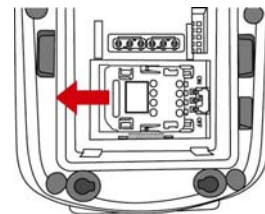

6. Put the battery back into the battery compartment and replace the battery compartment cover.

## Using the Barcode Laser Scanner

---

The PA690 has an integrated laser scanner, which reads all major 1D barcode labels with excellent performance.

**NOTE:** The reading software must be enabled in order to operate the scanner. This can be a user-loaded application or a pre-loaded utility such as Scanner Settings and Scan2Key.

To launch the Scanner Control Panel, follow these instructions:

1. Tap Start → Settings → System
2. Tap the Scanner icon. The Scanner Control Panel appears.

**NOTE:** Or press Func key and “7” simultaneously to bring up the Scanner Control Panel screen.

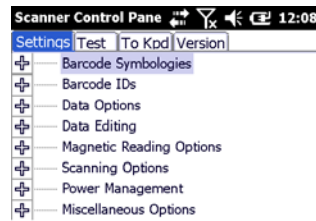

In the Scanner Control Panel screen, you can configure barcode scanner parameters such as enabling or disabling barcode symbologies, setting data transmission options, configuring magnetic and proximity reading options, and setting power management options. See the section of *Barcode Symbologies*.

To test the barcode laser scanner, follow these instructions.

1. Tap the Test tab to activate the demo program.
2. Tap Tools → Enable Scan.  
Or tap Tools → Auto-Scan → Start Auto-Scan.  
Define the scan interval. Tap Start.

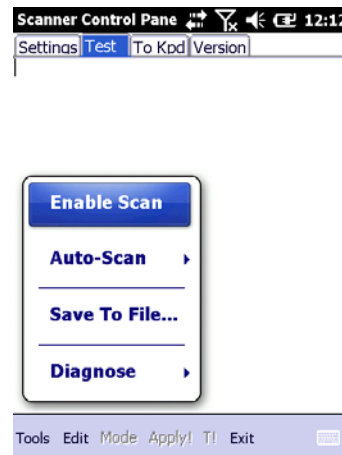

3. Aim the laser scanner at the selected barcode, and press either one of the scanner trigger buttons on the device.  
If you enable Auto-Scan, you don't have to press any button. Aim the laser scanner at the selected

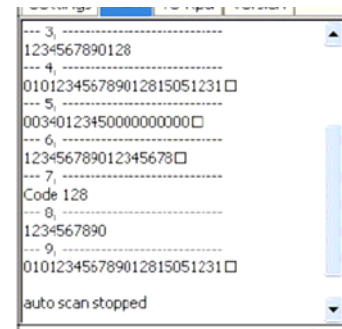

barcode while the laser emits light at regular intervals. The scanned barcode data appears on the screen.

4. Tap Tools → Auto-Scan → Stop Auto-Scan.



## Getting Connected

The PA690 enables users to link to a host computer using an RS-232 cable, or Bluetooth, WiFi, or GPRS connection for data communication. This chapter provides an overview of the PA690 communication options.

### Establishing Device-PC Connection

---

#### Installing Microsoft ActiveSync

In order to exchange data between your computer and the PA690, Microsoft Active-Sync must be installed on your computer. Use the USB/RS232 charging cable that comes with your device or the docking station to connect the device to your computer.

**NOTE:** If you have a previous version of the Microsoft ActiveSync installed in your computer, uninstall it first before installing the latest version of Microsoft ActiveSync.

To install Microsoft ActiveSync on your computer:

1. Close any open programs, including those that run at startup, and disable any virus-scanning software.
2. Download the ActiveSync software from the Microsoft ActiveSync Download page at <http://www.microsoft.com/downloads/details.aspx?Fami-lyID=7269173a-28bf-4cac-a682-58d3233efb4c&DisplayLang=en>.
3. Browse to the location of the downloaded file, and double-click it. The installation wizard begins.
4. Follow the instructions on the screen to install Microsoft ActiveSync.

## Connecting the Device to Your Computer

1. After ActiveSync has been installed, connect the PA690 to your PC as described in Connecting the terminal to a host (PC/Notebook).
2. Turn the PA690 on.
3. ActiveSync starts automatically and configures the USB port to work with the PA690. The New Partnership setup wizard automatically starts.

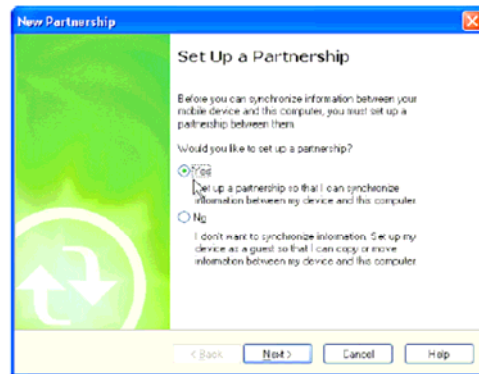

**NOTE:** If ActiveSync doesn't start automatically, click Start → Programs → Microsoft ActiveSync.

**NOTE:** If a message appears indicating that it is unable to detect a connection, click the Cancel button and manually configure the communication settings.

4. Follow the on-screen instructions.
5. When the configuration process is complete, the Active-Sync window appears.

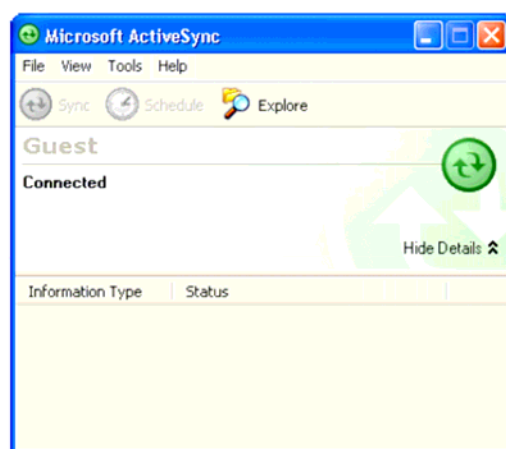

6. Synchronization will be initialized and will take place if you've chosen to synchronize periodically or upon connection.

**NOTE:** Your computer can create a partnership with multiple PA690s. Also, a PA690 can create a partnership with up to two computers.

## WiFi Connection

A wireless network can be added either when the network is detected or by manually entering network settings. Before following these instructions, make sure if authentication information is needed.

### Using the Summit Utilities

You can use the Summit Client Utility tool to setup or change the WiFi settings.

#### Admin Login

1. Tap Start → Setting → System → Wi-Fi.  
The Summit Client Utility window appears.

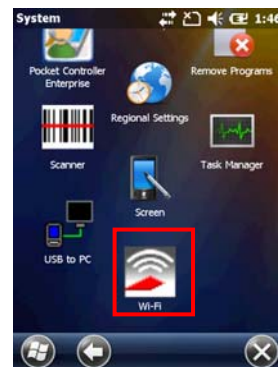

2. To login as an administrator, tap Admin Login.



3. Enter the Admin Password. (Default password: SUMMIT)

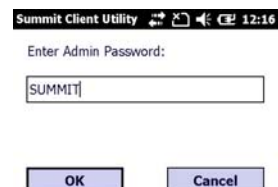

## 4. Tap **Profile** to scan available APs



### Scan Available AP

#### 1. Under Profile tab, tap Scan for available AP.



#### 2. You may select a desired AP to create a new profile. Tap **Configure**.

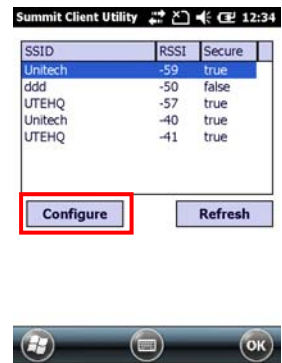

#### 3. Tap **Yes** to create the new profile.



4. Enter the WEP key or network key. Tap OK.



## Commit and Activate

1. Tap Commit to activate the setting.
2. Under the Main tab, select the profile you want to activate from the drop-down menu of the Active Profile.
3. Under the Status tab, you can see the IP address, signal strength and quality.



4. Tap OK to exit the Summit Client Utility.
5. If you want to disconnect the AP, tap Disable Radio.



## u-CenterMobile for Quick GPS Connection

Before you start to use your device for GPS navigation, use the u-CenterMobile program first to download ephemeris data (current satellite position and timing information) onto your device. This data is needed to accelerate GPS positioning.

u-CenterMobile allows you to download ephemeris data from a specified Web server or satellite; you may use the Internet connection on your device, which can be via ActiveSync, WIFI, or GPRS to download from the server. This download significantly speeds up GPS positioning.

### To Open u-CenterMobile

1. Tap Start → u-CenterMobile.

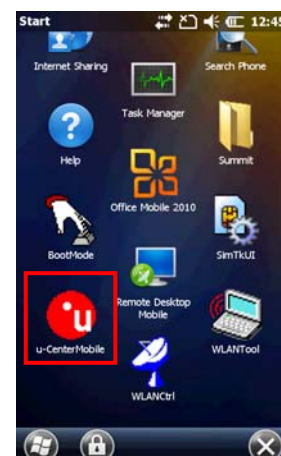

- The u-CenterMobile program appears.

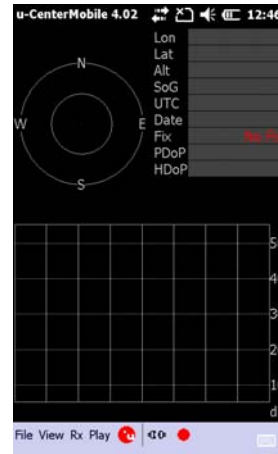

## To Download Data

Please follow the following steps to download the ephemeris data.

- Tap Rx → Autobauding.

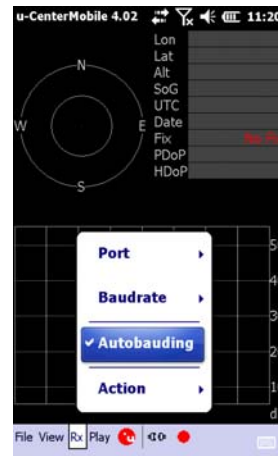

- Tap Rx → Port.

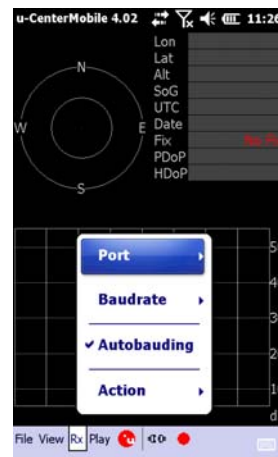

3. Select **COM4**.

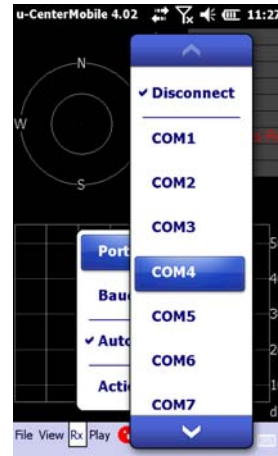

4. The tool starts to download the ephemeris data (current satellite position and timing information).



5. When the download is finished, you will see the data shown in the upper right corner.

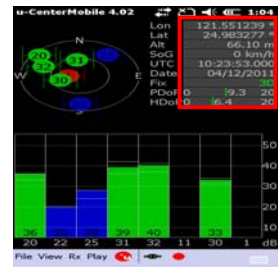

## Barcode Scanner Programs

The PA690 provides an option for the barcode scanner, allowing you to scan and decode various types of 1D/2D barcodes.

### Scanner Setting

When it is necessary for the user to change the default barcode symbology for a different application, the Scanner Control Panel provides the ability to change default symbology, place delimiter characters behind scanned data, and save the settings.

Tap Start → Settings → System → Scanner.

The Scanner Control Panel appears.

**NOTE:** Press Func key and “7”.

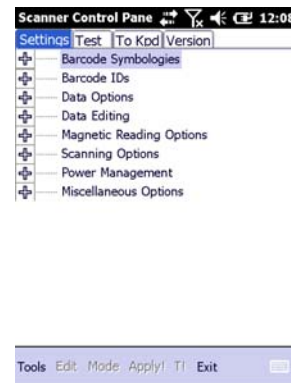

### Scan2Key

The Scan2Key application routes input from a scanner port to a keypad buffer, making all input from the scanner emulate input from the keypad. Using the Scan2Key, scanned data will be directed from the scanner port to any waiting (active/focused) text editor such as MS Mobile Word or a text box in an application.

## Barcode Symbologies

Barcode Symbology	Enable / Disable	Char Check / Digit verification	Transmit Check Char/digit	Others
Australian Post	YES			Send bar width data
British Post	YES			
Canadian Post	YES			
Codabar	YES	YES	YES	Transmit start & stop char, *data length
Code 11	YES	YES		*data length
Code 128/EAN 128	YES			*data length
Code 39	YES	YES	YES	For ASCII, Transmit start & stop char, Append mode, *data length
Code 93	YES			*data length
Dutch (KIX) Post	YES			
EAN 13	YES		YES	2 digit addenda, 5 digit addenda, Addenda required, Include addenda separator
EAN 8	YES		YES	2 digit addenda, 5 digit addenda, Addenda required, Include addenda separator
IATA 2 of 5	YES			*data length
Interleaved 2 of 5	YES	YES	YES	*data length
ISBT	YES			
Japanese Post	YES			
Korean Post	YES			*data length
Matrix 2 of 5	YES			*data length
MSI	YES		YES	*data length
Planet	YES		YES	
Postnet	YES		YES	

Barcode Symbology	Enable / Disable	Char Check / Digit verification	Transmit Check Char/digit	Others
RSS (Databar)	YES			*data length
UPC A	YES		YES	2 digit addenda, 5 digit addenda, Addenda required, Include addenda separator, Send number system
UPC E	YES		YES	2 digit addenda, 5 digit addenda, Addenda required, Include addenda separator, Send number system, Expanded UPC-E
UPC E1	YES		YES	2 digit addenda, 5 digit addenda, Addenda required, Include addenda separator, Send number system, Expanded UPC-E

**NOTE:** \*Value Adjustable Scanner Control Panel Version 5.14

## Barcode Symbologies 2D

Barcode Symbology	Enable / Disable	Char Check / Digit verification	Transmit Check Char/digit	Others
Aztec	YES			Runes, *data length
Codablock F	YES			*data length
Code 49	YES			*data length
Data Matrix	YES			*data length
EAN-UCC Composite	YES			UPC composite, *data length
MaxiCode	YES			*data length
MicroPDF417	YES			*data length
OCR	YES			OCR mode, OCR direction, Template, Group G, Group H, Check character
PDF-417	YES			*data length
QR Code	YES			
TLC-39 (TCIF Linked Code 39)	YES			

**NOTE:** \*Value Adjustable Scanner Control Panel Version 5.14



## Advanced Settings

### Performing a Hardware Reset

You may have to perform a reset if the device freezes (i.e., the device no longer responds to the buttons or tapping on the screen).

A soft reset allows your device to get a fresh start, similar to rebooting a computer.

This will restart your device and adjust memory allocation. All records and entries are retained after a soft reset. Unsaved data in open programs may be lost.

### Performing a Warm Boot

1. Remove the stylus from its holder.
2. Lightly press the tip of the stylus to the reset button located at the right side of the scan button.

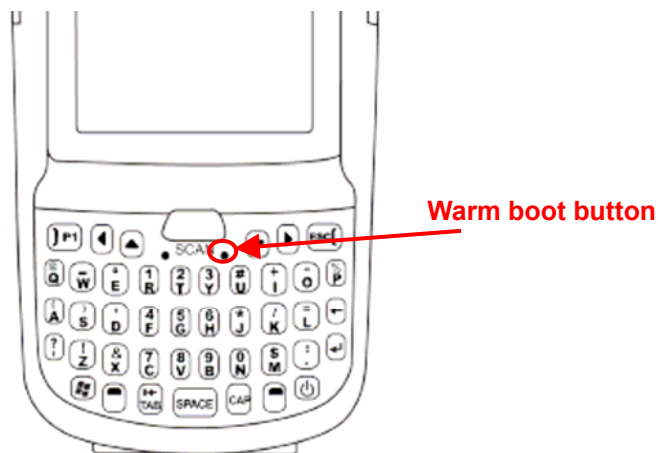

### Performing a Cold Boot

A cold boot will erase all data and all programs you have added, and will restore the device to the default factory settings.

Never perform a cold boot unless a warm boot does not correct your problem.

When you perform your next ActiveSync operation, you can restore any data that you previously synchronized to your computer or you can restore data that you backed up to a storage card.

## Method 1: From Windows Mobile

1. Tap Start → BootMode.  
The BootMode Screen appears.



2. Tap Cold Boot.  
The system is reset and you will lose all data including all files in the RAM memory.

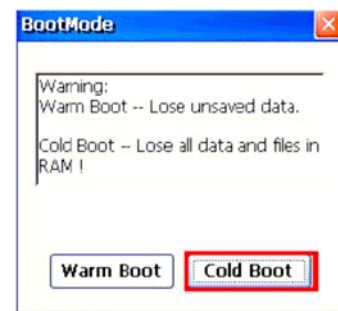

## Method 2: From Hardware

To start the cold boot for the PA690, press and hold the left trigger button and then press the reset button with a stylus.

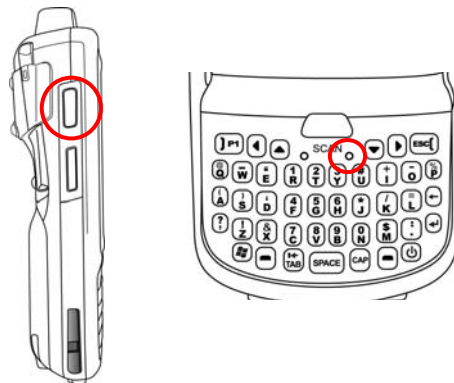

**NOTE:** When you perform hard reset, the data and time settings will not be retained. Formats, preferences and other settings are restored to their default factory settings.

## System Specification

CPU	Marvell PXA320 806MHz	
Memory	Mobile DDR: 256MB NaNDFlash: 512MB	
OS	Phone version -- Windows Embedded Handheld 6.5 professional version Without phone version -- Windows Embedded Handheld 6.5 classic version	
Keypad	Numeric keypad -- Total 26 keys (including power key) QWERTY keypad -- Total 44 keys (including power Key)	
Display	WVGA, 3.8" Color Transflective TFT-LCD with touch screen & backlight	
Barcode Scanner	1D Laser scan engine (Optional) 2D Imager (Optional)	
Camera	5.0M Pixel, 15 pix/sec	
Flash Light	LED	
Indicator	LEDs Vibrator	
Audio	MIC, speaker, headset connector, receiver	
Address Locating	GPS	
Expansion Slot	MicroSD memory card slot	
Power Source	Main battery (Li-ion)	2200mAh / 3.7V, 3.5 hrs. for full charge 4000mAh / 3.7V, 7 hrs. for full charge
	Backup battery	One Ni-MH backup battery rechargeable
Enclosure	Weight	390g with 2200mAh Battery 430g with 4000mAh Battery

	Dimension	Approximately 177.66mm (L) x 40.41mm (H) x 74.58mm (W) (Antenna length included)
Environmental	Operating temperature	-10 °C ~ 50 °C
	Charging temperature	0 °C ~ 40 °C
	Storage temperature	-20 °C ~ 60 °C
	Relative humidity	5% ~ 95% (non-condensing)
	Drop test to concrete	1.5 Meter
	Environmental sealing	IP65
Models	BT + WIFI + Camera	
	BT + WIFI + Camera + GPS + 3.5G	
Regulatory Approvals	CE, FCC, VCCI, CCC, NCC	
Software	Microsoft Visual Studio 2005 Microsoft Windows Mobile 6.5 SDK	
Accessories	Manual CD Stylus Battery Elastic Stylus String Hand Strap Power Adaptor & plugs	

## Appendix II

### Worldwide Support

Unitech's professional support team is available to quickly answer questions or assist with technical-related issues. Should an equipment problem occur, please contact the nearest Unitech regional service representative. For complete contact information please visit the Web sites listed below:

Region	Web Site
Global Operation Center	<a href="http://www.ute.com">http://www.ute.com</a>
Unitech Taiwan	<a href="http://tw.ute.com">http://tw.ute.com</a>
Unitech Asia Pacific & Middle East	<a href="http://apac.ute.com">http://apac.ute.com</a> ; <a href="http://india.ute.com">http://india.ute.com</a>
Greater China Division	<a href="http://cn.ute.com">http://cn.ute.com</a>
Unitech Japan	<a href="http://jp.ute.com">http://jp.ute.com</a>
Unitech America	<a href="http://us.ute.com">http://us.ute.com</a> ; <a href="http://can.ute.com">http://can.ute.com</a>
Unitech Latin America	<a href="http://latin.ute.com">http://latin.ute.com</a>
Unitech Europe	<a href="http://eu.ute.com">http://eu.ute.com</a>